

**Operating Instructions  
Instrucciones de funcionamiento**

Video Cassette Recorder

# NV-HS1000EC

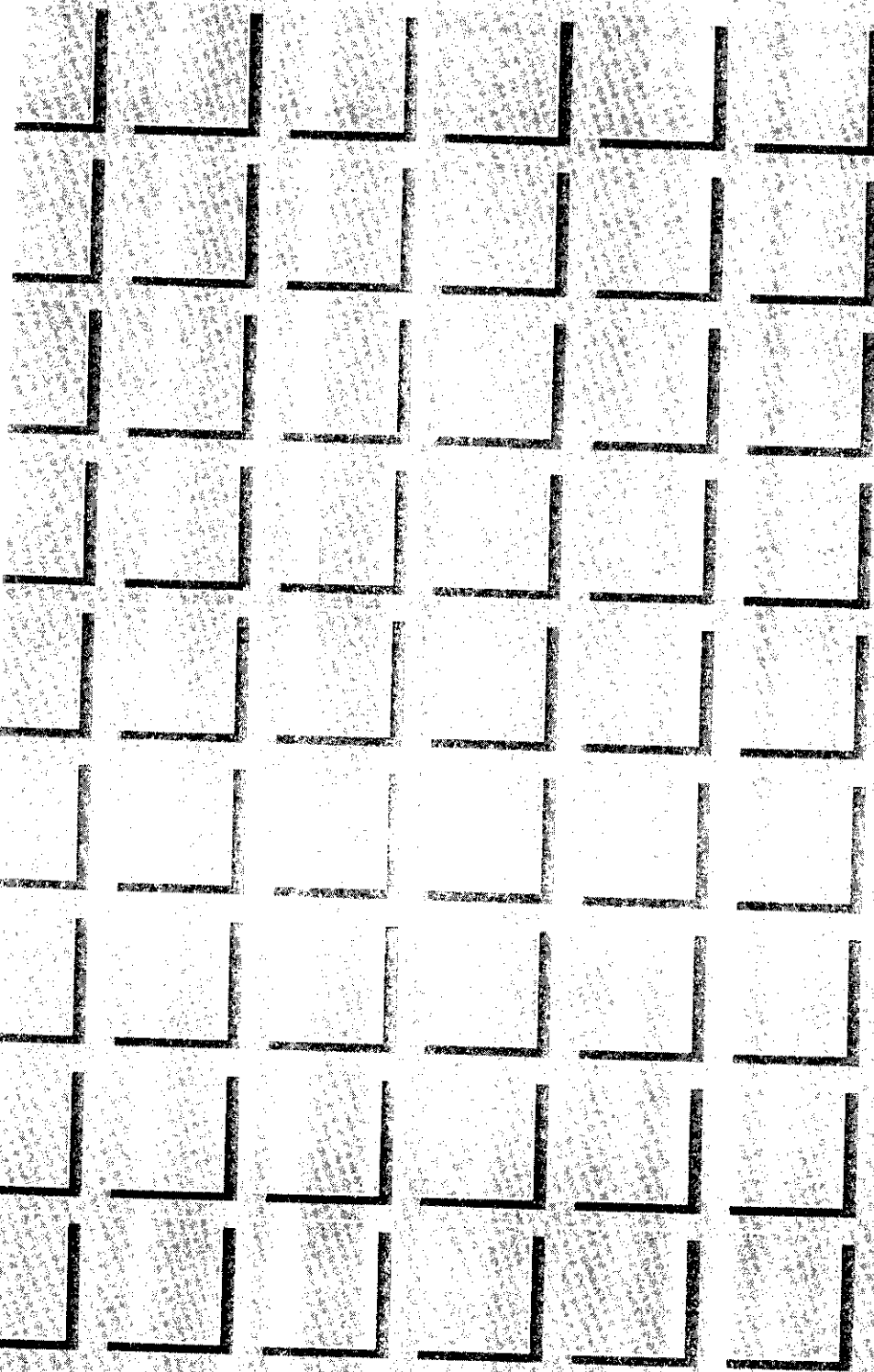

**SHOWVIEW**

VQT5799



VHS  
PAL



Before attempting to connect, operate or adjust this product,  
please read these instructions completely.

# Dear Customer

May we take this opportunity to thank you for purchasing this Panasonic Video Cassette Recorder.

We would particularly advise that you carefully study the Operating Instructions before attempting to operate the unit and that you note the listed precautions.

## ShowView Programming System

Programming is now easier than ever: simply enter the ShowView number provided in the programme schedule column carried by newspapers and magazines.

- ShowView is a trademark applied for by Gemstar Development Corp. ShowView system is manufactured under licence from Gemstar Development Corporation.

## AI Crystal View Control

AI circuit for automatic tape calibration (computer-controlled calibration) and optimizing of playback characteristics.

During playback the contrast of tapes recorded with good level is automatically optimized; when a tape recorded with insufficient level is played back, the noise reduction circuit is activated automatically. The computer-controlled calibrating process requires only 1.5 seconds for detecting the tape data and completing the setting. This process has a positive effect on used video heads as well.



# Contents

## IMPORTANT

Your attention is drawn to the fact that recording of pre-recorded tapes or discs or other published or broadcast material may infringe copyright laws.

## WARNING

TO REDUCE THE RISK OF FIRE OR SHOCK HAZARD, DO NOT EXPOSE THIS EQUIPMENT TO RAIN OR MOISTURE.

This model conforms to the EC directive (for radio interference) 87/308/EEC.

## FOR YOUR SAFETY

### ■ DO NOT REMOVE OUTER COVER.

To prevent electric shock, do not remove cover. No user serviceable parts inside. Refer servicing to qualified service personnel.

## Setting Up

Precautions .....	4
Connections .....	5
Tuning the TV to your VTR .....	8
Setting the Clock of the VTR .....	9
Storing TV Broadcasts into your VTR .....	12
Setting the Remote Controller for Operation of your TV .....	16
Initial Settings Using On Screen Displays .....	18

## Basic Operations

Playback .....	20
On-the-spot Recording .....	22

## Advanced Operations

Timer Recording .....	24
•Using the Remote Controller .....	26
•ShowView Programming .....	28
Other Functions .....	29

## Editing Operations

Editing Preparation .....	33
•Connections .....	33
•Editing Functions .....	34
•Flow Chart for On Screen Displays .....	36
Manual Editing .....	38
•Copying .....	38
•Insert, AV Insert Editing and Audio Dubbing .....	40
Programme Editing .....	42
•Assemble Editing .....	42
•Insert, AV Insert Editing and Audio Dubbing .....	44
•Other Editing Functions .....	47
Editing when not Using an Edit Cable .....	50

## Description

Controls and Connection Sockets .....	52
Infra-red Remote Controller .....	58

## Helpful Hints

Before Requesting Service .....	60
Specifications .....	62

# Precautions

---

Please read these cautions before you operate this VTR.

---

## Avoid Sudden Changes in Temperature

If the VTR is suddenly moved from a cold place to a warm place, moisture may form on the tape and inside the VTR.

---

## Humidity and Dust

Avoid places where there is high humidity or much dust, which may cause damage to internal parts.

---

## Do Not Obstruct the Ventilation Holes

The ventilation holes prevent abnormal increase in temperature. Do not block or cover these holes. Especially avoid covering the holes with soft materials such as cloth or paper.

---

## Keep away from High Temperature

Keep the VTR away from extreme direct heat such as direct sunlight, heating radiators, or closed automobiles.

---

## Keep Magnets away

Never bring a magnet or magnetized object near the VTR because it will adversely affect the performance of the VTR.

---

## No Fingers or Other Objects Inside

Touching internal parts of this VTR is dangerous, and may cause serious damage to the VTR. Do not attempt to disassemble the VTR. There are no user serviceable parts inside.

---

## Keep Water away

Keep the VTR away from flower vases, tubs, sinks, etc. CAUTION: If liquids are spilled into the VTR, serious damage could occur. If you spill any liquid into the VTR, consult qualified service personnel.

---

## Lightning

To avoid damage by lightning, disconnect the aerial plug from the VTR.

---

## Cleaning the VTR

Wipe the VTR with a clean, dry cloth. Never use cleaning fluid, or other chemicals. And do not use compressed air to remove dust.

---

## Stacking

Place the VTR in a horizontal position, and do not place anything heavy on it.

---

## Video Head Clogging

The video heads place picture signals on the tape during recording and read picture signals from the tape during playback and they are, therefore, of critical importance for the picture quality. If the VTR is used over extremely long periods of time, these heads may still become dirty and clogged. In such a case, the signals can no longer be recorded correctly, and the playback picture will be distorted accordingly. This is the case, for example, during the playback of a tape, the sound is reproduced normally, but no picture is seen, or the picture is greatly distorted. When such a symptom case occurs have the recorder checked by qualified service personnel.

---

## Condensation may form in the VTR if:

- The VTR is in a room when the heater has just been turned on.
- The VTR is in a room with steam or high humidity.
- The VTR is brought from cold surroundings into a well-heated room.
- The VTR is suddenly brought from cool surroundings, such as an air-conditioned room or car, to a place which is hot and humid.

### Note:

Do not operate the VTR for at least 1 hour if any of the above conditions occur.

This VTR does not incorporate a dew sensor.

# Connections

Precautions  
Connections

This tells you how to connect with an aerial, TV, etc.

## Basic Connections

The following connections are required to record and play back the VTR through TV set:

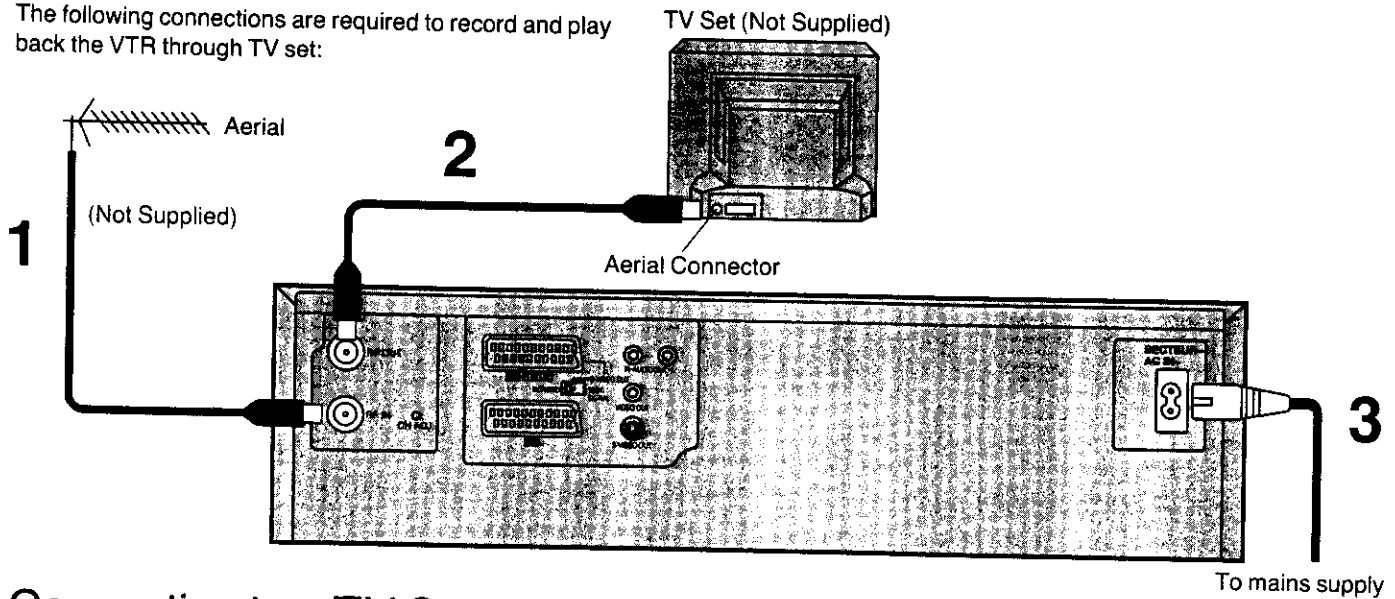

## Connection to a TV Set with 21-Pin Scart Terminal

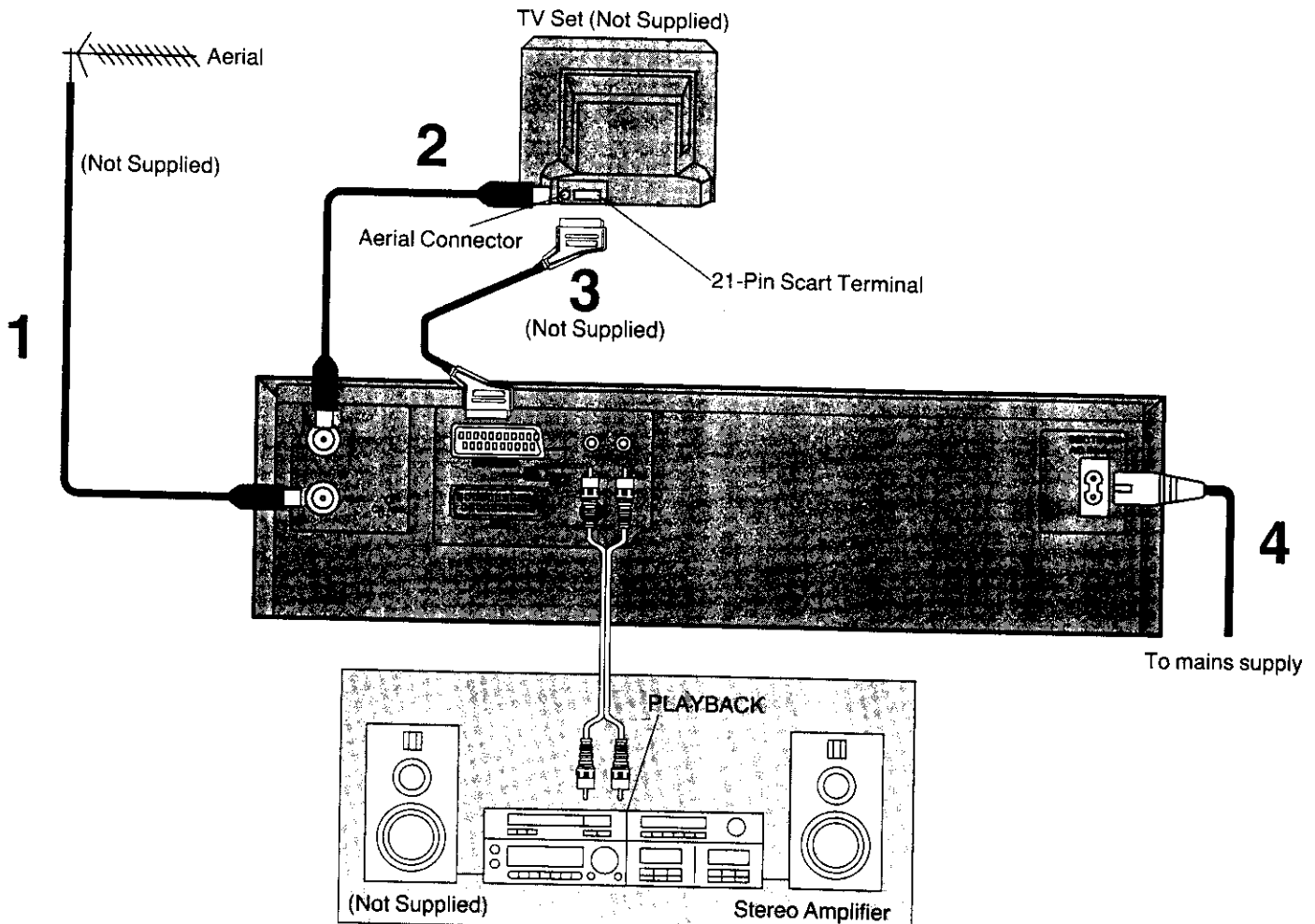

### • Connection to a Stereo Amplifier

## Connection to a TV Set with S-Video Socket

This VTR uses the S-VHS format that makes it possible to obtain high resolution and high picture quality by using the high-performance S-VHS video cassette tapes.

The conventional video sockets of VTRs output (input) a combination of the luminance signal (Y) and colour signal (C) which are recorded on the video tape. The new S (Separate)-Video Socket allows separate transmission of signals in order to obtain clearer pictures.

The connection with the S-Video Cable can also be used for playback of a tape that was recorded in the conventional VHS system. The "S" in the "S-Video Socket" stands for "SEPARATED Y/C" not for "S-VHS".

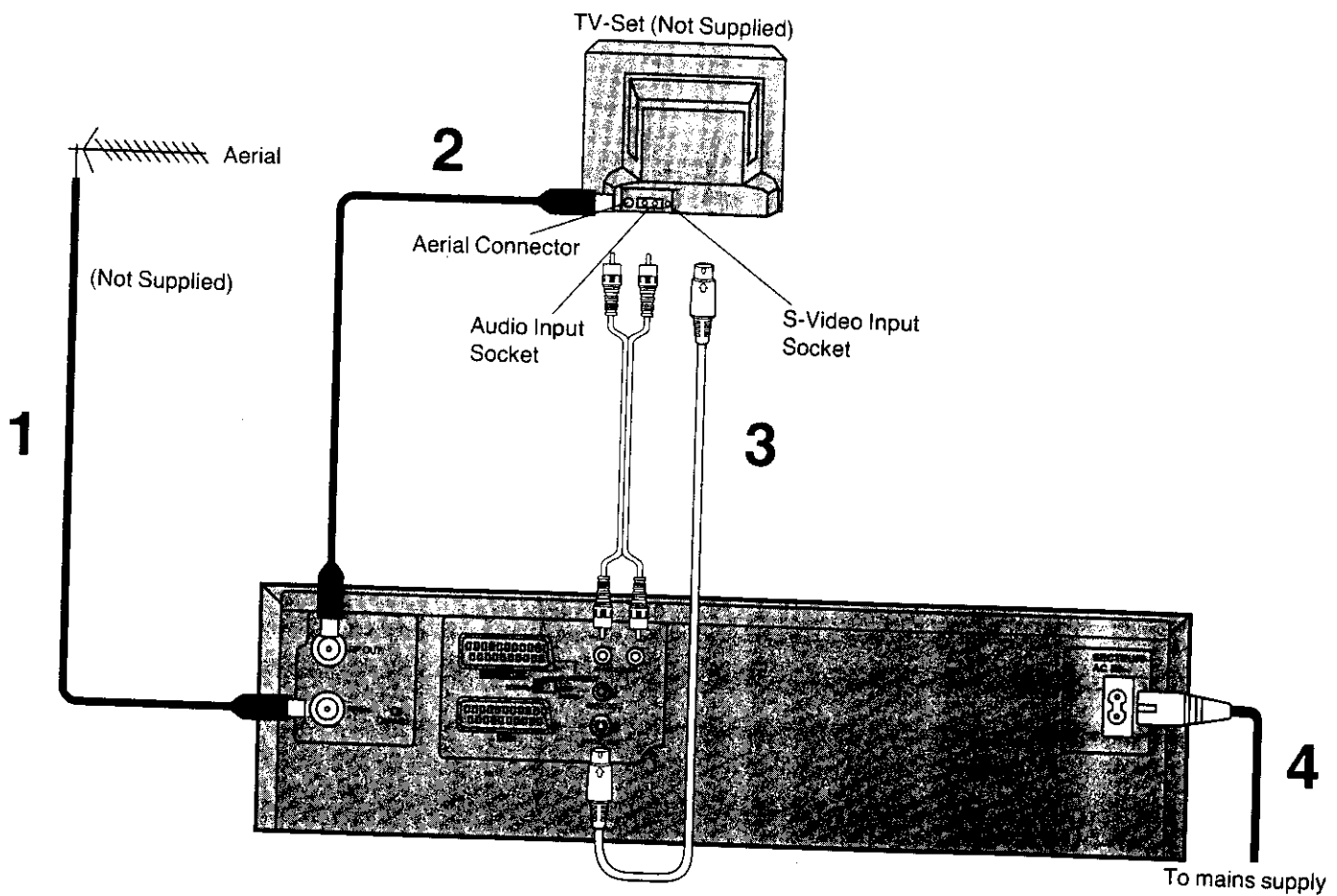

# Connection to a Decoder

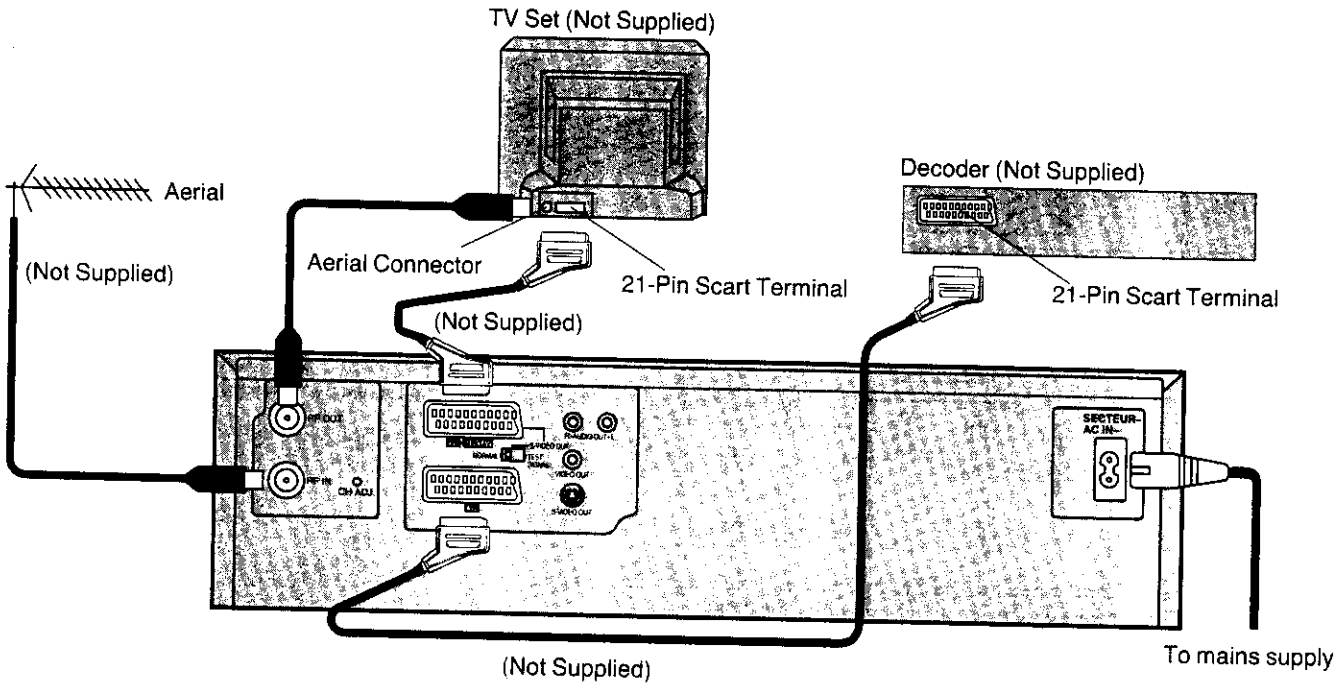

**Note:**

If the TV set is provided with an RGB-compatible connector, connect the 21-pin AV cable from the VTR to this connector. Use full-pin 21-pin AV cables for connecting the TV set and VTR and for connecting the VTR and decoder.

**AV LINK**

With this button the connected colour TV set can be switched from TV mode to VTR mode (vice versa) when it is connected by means of 21-pin scart cable.

This makes a variety of functions possible, such as simultaneous recording and viewing when a Pay TV (e.g. Canal Plus, Filmnet) decoder or a satellite receiver has been connected.

**VTR mode (VTR indicator lights):**

To enjoy sound and pictures from the VTR.

**TV mode (VTR indicator goes off):**

To watch another programme on the TV while recording on the VTR.

- Select the programme to be watched using the TV set's tuner.
- The sound and pictures of a different channel are received by the VTR.

	VTR	TV set
<b>Power On</b>	VTR mode	AV input selected
	TV mode	Input from TV set's tuner*
<b>Power Off</b>	—	Input from TV set's tuner

\*When the VTR is set to the TV mode and the Pay TV channel is selected, the signals will still be scrambled even when Pay TV is selected by the TV set's tuner. At a time like this, either set the VTR to the VTR mode or switch the TV set's input signals to AV input.

# Tuning the TV to your VTR

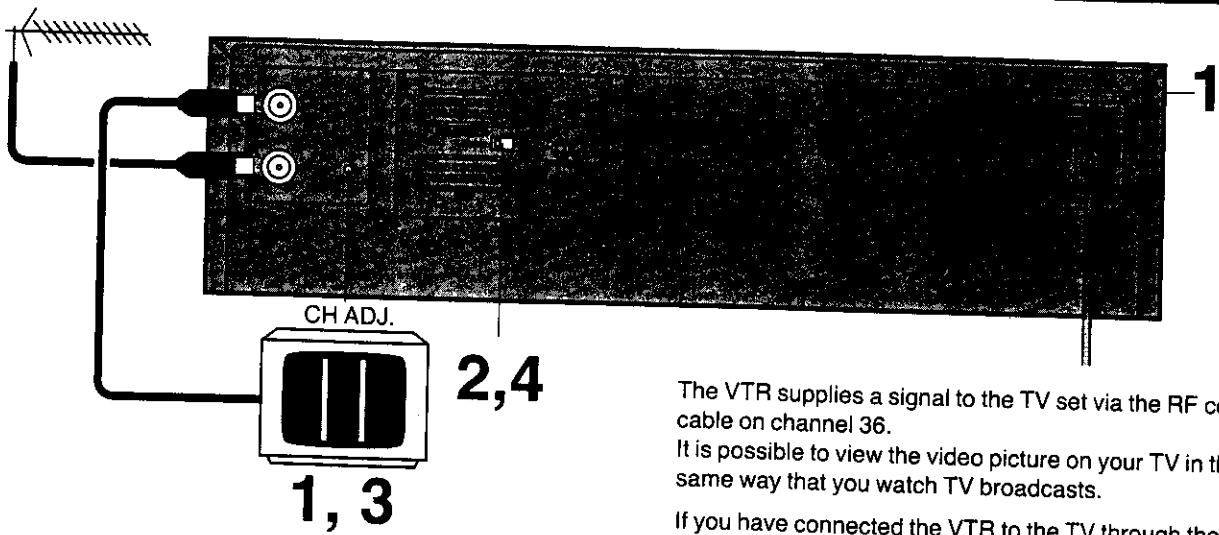

The VTR supplies a signal to the TV set via the RF coaxial cable on channel 36.

It is possible to view the video picture on your TV in the same way that you watch TV broadcasts.

If you have connected the VTR to the TV through the 21-pin scart terminal or Audio/Video/S-Video output sockets then you do not need to follow the procedure mentioned below.

## Operations

1



Turn on the TV and VTR.

2

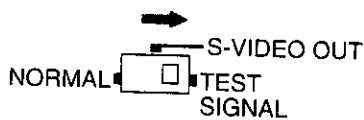

To generate a test pattern, set **NORMAL/S-VIDEO OUT/TEST SIGNAL** to **TEST SIGNAL**.

3



Set the TV to an unused position which you wish to use for your video playback.

4

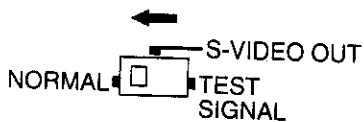

Set **NORMAL/S-VIDEO OUT/TEST SIGNAL** to **NORMAL**.

### Note:

The test signal is transmitted on video channel 36. If you are encountering interference from a TV broadcast on this video channel, you may readjust to another free channel (32~40) by using the **CH ADJ.** screw which is located on the rear of the VTR. When rotating the **CH ADJ.** screw, take care not to turn it too far. Please note that if the **CH ADJ.** screw is used then you will have to retune your TV to the test signal as in item 2 to 4 above.



# Setting the Clock of the VTR

Tuning the TV to your VTR  
Setting the Clock of the VTR

By setting the time on the remote controller's clock and then by transmitting this setting to the VTR, the clocks on both the remote controller and VTR display the same time. The built-in digital clock employs the 24-hour system.

## Preparation

- Turn on the VTR.
- Install the batteries in the remote controller. See page 17.

## For Example:

Date; 16th, October, 1999  
Time; 20:15

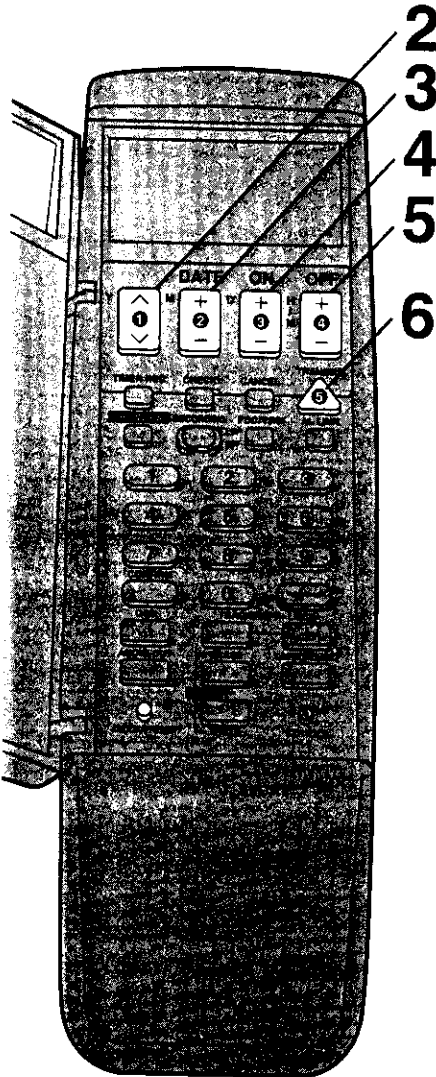

Operations	Display Symbols	
1		Open the door of the remote controller.
2		Set Year "99".
3		Set Month "10".
4		Set Date "16".
5		Set Time "20:15". • When it is kept pressed, the indication changes in 30-minute steps.
6		Press TRANSMIT.
7		Close the door of the remote controller.

### Note:

To change the previous clock setting, press **CLOCK/PRESET** for at least 2 seconds. The previous clock setting will be displayed. Then follow steps 2 to 7 above.

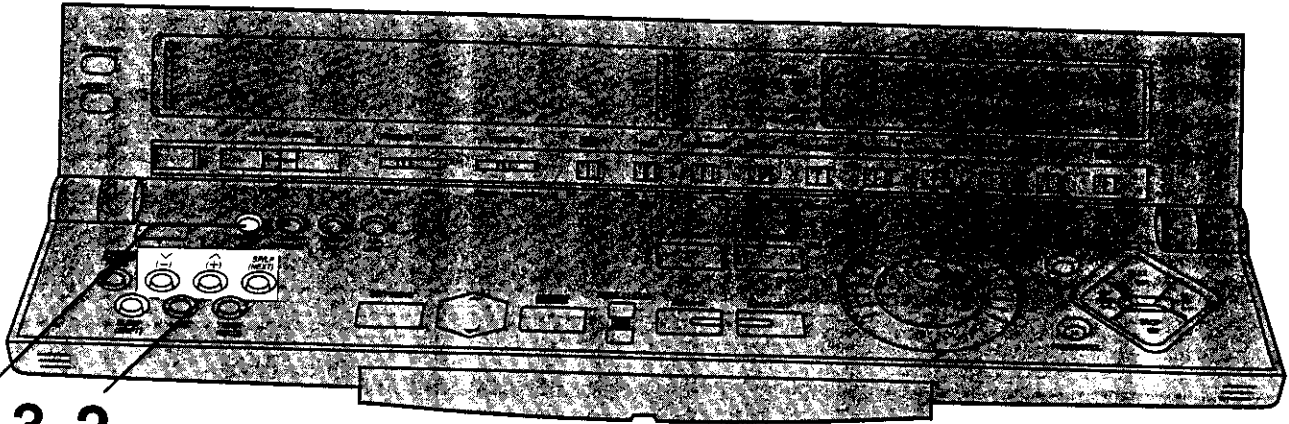

**1, 3 2**

In addition to setting the VTR clock from the remote controller, it can also be set directly from the VTR. The built-in clock is used to activate the timer for automatic recording and must be set to the correct time.

The built-in digital clock employs the 24-hour system.

**Preparation**

Turn on the VTR.

**For Example:**

Date; 16th, October, 1999

Time; 20:15

**Operations**

**Display Symbols**

**1**  Keep **CLOCK SET** pressed for more than 2 seconds.

**2** Set each item by pressing **^ (+)** or **v (-)** and **SP/LP (NEXT)**.

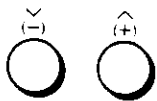

Set Year "99".



Set Month "10".



Set Date "16".



Set Hour "20".



Set Minute "15".

• There is no need to press **SP/LP (NEXT)**.

**3** 



Press **CLOCK SET**.

• The clock will start.

**Note:**

The clock operates for at least 60 minutes by its backup system in the event of power failure.

### Time Reset Function

If the clock is less than two minutes slow or fast, it can easily be reset to the proper time.

**For example:**

Resetting the clock to 12:00.00

- 1 Keep **CLOCK SET** pressed at any time between 11:58.00 and 12:01.59 for more than 2 seconds.
- 2 Press **CLOCK SET** again as soon as you hear the 12:00.00 time signal.

### Summer Time Function

#### Setting to summer time

- 1 Keep **CLOCK SET** pressed for more than 2 seconds.
- 2 Press **SLEEP (SHIFT)**.
  - The time on the clock is advanced by 1 hour.
- 3 Press **CLOCK SET**.

#### Returning from summer time to standard time

- 1 Keep **CLOCK SET** pressed for more than 2 seconds.
- 2 Press **SLEEP (SHIFT)** twice.
  - The time on the clock is set back by 1 hour.
- 3 Press **CLOCK SET**.

# Storing TV Broadcasts into your VTR

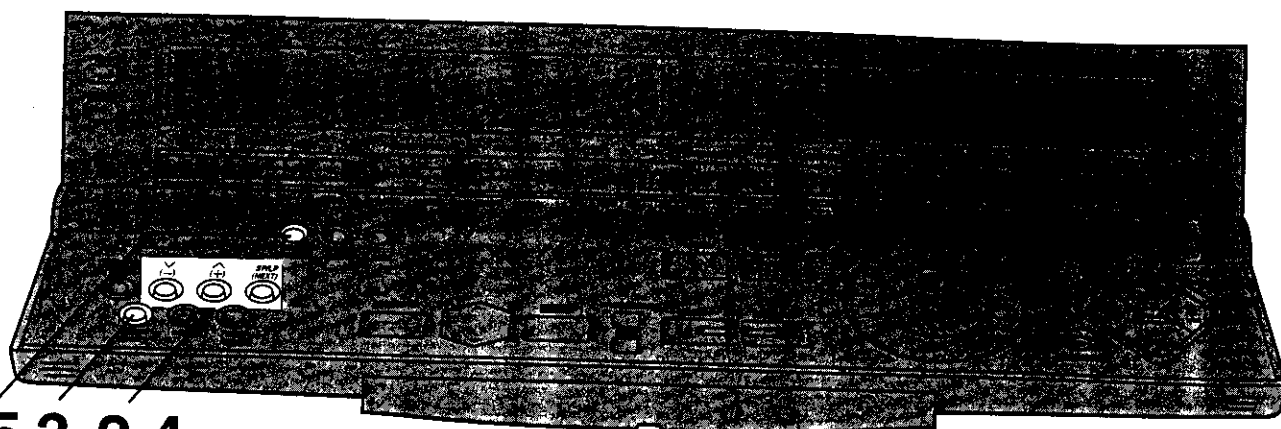

1,5 3 2,4

## Introduction







The VTR is fitted with its own tuner (just like a normal TV set) and can be pre-set to receive up to 99 TV broadcast stations.

## Preparation

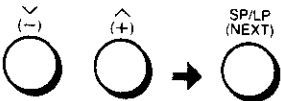
- Confirm that the TV is on and the VTR viewing channel is selected.
- Turn on the VTR and Select the programme position except A1, A2 and A3.

## Operations

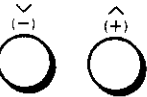
## Display Symbols

- |  |   |
|--|---|
| <p><b>1</b></p>  <p>TUNER PRESET</p>  | <p>Keep <b>TUNER PRESET</b> pressed for more than 2 seconds.</p>  |
| <p><b>2</b></p>                        | <p>Select the programme position, then press <b>SP/LP (NEXT)</b>.</p>   |
| <p><b>3</b></p>  <p>SLEEP (SHIFT)</p>  | <p>Select normal TV station or Pay TV (e.g. Canal Plus, Filmnet) station.</p> <ul style="list-style-type: none"> <li>•1: To preset normal TV stations.</li> <li>•2: To preset Pay TV stations.</li> </ul> |
| <p><b>4</b></p>                        | <p>Search for the required TV station.</p> <ul style="list-style-type: none"> <li>• Press <b>SP/LP (NEXT)</b> and repeat steps 2-4 for each programme position you want to tune to a station.</li> </ul>  |
| <p><b>5</b></p>  <p>TUNER PRESET</p>  | <p>Press <b>TUNER PRESET</b> twice.</p>   |

### Direct Channel Input Tuning Procedure

If you know the channels on which the TV stations can be received, the TV stations can be tuned in by following the steps given below.

- 1 Keep **TUNER PRESET** pressed for more than 2 seconds.
- 2 Select the programme position by using  $\wedge$  (+) or  $\vee$  (-), then press **SP/LP (NEXT)**.
- 3 Select normal TV station or Pay TV (e.g. Canal Plus, Filmnet) station by pressing **SLEEP (SHIFT)**.
  - 1: To preset normal TV stations.
  - 2: To preset Pay TV stations.
- 4 Input the channel number for the required TV station by using Number buttons on the remote controller.
  - Press **SP/LP (NEXT)** and repeat steps 2-4 for each programme position you want to tune to a station.
- 5 Press **TUNER PRESET** twice.

### Fine Tuning Procedure

- 1 Keep **TUNER PRESET** pressed for more than 2 seconds, and then press again.
- 2 Press **SP/LP (NEXT)**.
- 3 Press  $\wedge$  (+) or  $\vee$  (-) to obtain the best tuning condition.
  - "AFC" Indicator disappears.
  - To return the tuning to its former state, press **SLEEP (SHIFT)**.
- 4 Press **TUNER PRESET**.

### Blanking of Unoccupied Programme Positions

- 1 Keep **TUNER PRESET** pressed for more than 2 seconds.
- 2 Select a programme position which you do not want to tune to a TV station, by using  $\wedge$  (+) or  $\vee$  (-).
- 3 Press **SLEEP (SHIFT)**. ("—" is displayed.)
  - Repeat steps 2 and 3 for another unoccupied programme positions to skip during the selection of the programme positions.
  - To cancel the blanking of a programme position, select that programme position on the VTR and then press **SLEEP (SHIFT)**.
- 4 Press **TUNER PRESET** twice.

### Channel Plan

Channel Indication	TV Channel
2-12	E2-E12
13-20	—
21-69	21-69
74-76	S1-S3
80-82	M1-M3
83-89	M4-M10
90-99	U1-U10
121-141	S21-S41

# Setting Up the Remote Controller for the ShowView Programming

This remote controller uses specially designated numbers called "guide numbers" to differentiate between the TV stations. Before programming using the ShowView numbers, you must enter the guide numbers of the TV stations to be viewed and the programme positions at which those TV stations are received on the VTR into the remote controller. Have a newspaper or magazine at hand which lists the TV station guide numbers and ShowView numbers.

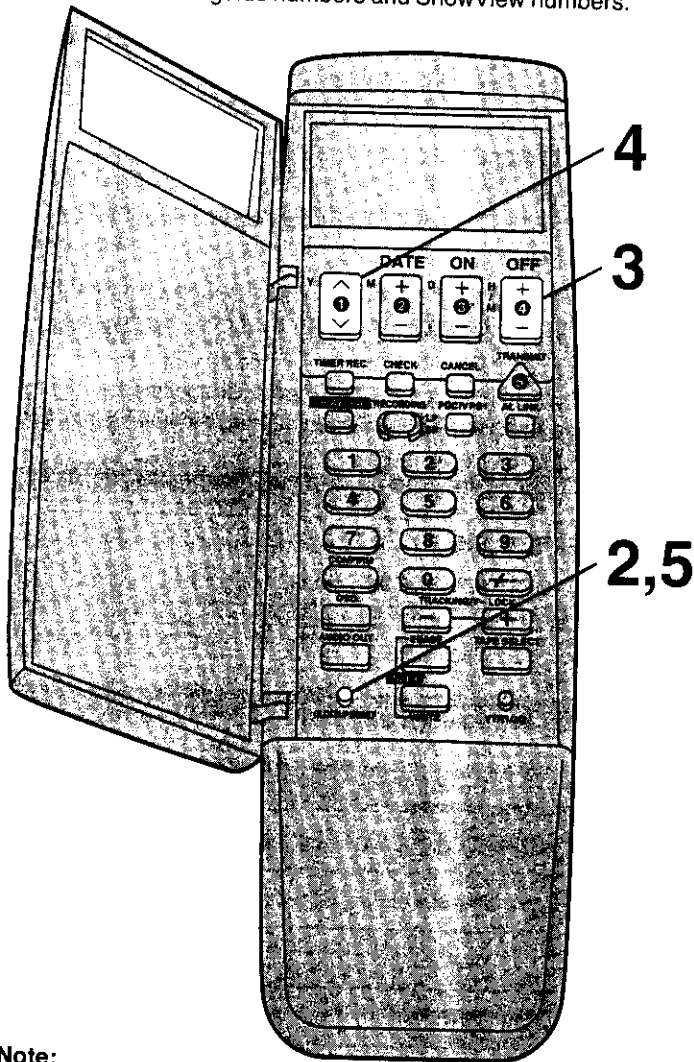

## Preparation

Set the clock of the remote controller first.

## For Example:

TV Station	Guide Number	Programme Position
ARD	001	1
ZDF	002	2
RTL	004	4
SAT1	005	3

## Operations

## Display Symbols

**1** Open the door of the remote controller.

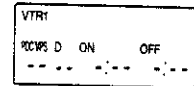

**2** Keep **CLOCK/PRESET** pressed for more than 2 seconds and then press it again.



**3** Select the guide number (001-255).

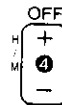

**4** Select the programme position (1-99, A1-A3).

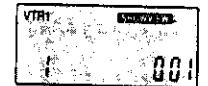

• To set the other TV stations, repeat steps 3 and 4.

**5** Press **CLOCK/PRESET** twice.



**6** Close the door of the remote controller.

## Note:

To receive satellite stations, the satellite receiver must be connected to the VTR and programme position must be set depending on the type of the connection made.

A1: When the satellite receiver is connected to the AV1 socket

A2: When the satellite receiver is connected to the AV2 socket

A3: When the satellite receiver is connected to the Audio/Video input sockets (AV3)

• When the satellite receiver is connected by means of the RF coaxial cable, set to a free programme position between 1 and 99.

### If you do not know the Guide Number of a TV Station

You can set it by figuring it out from the ShowView number for the programme broadcast by that station.

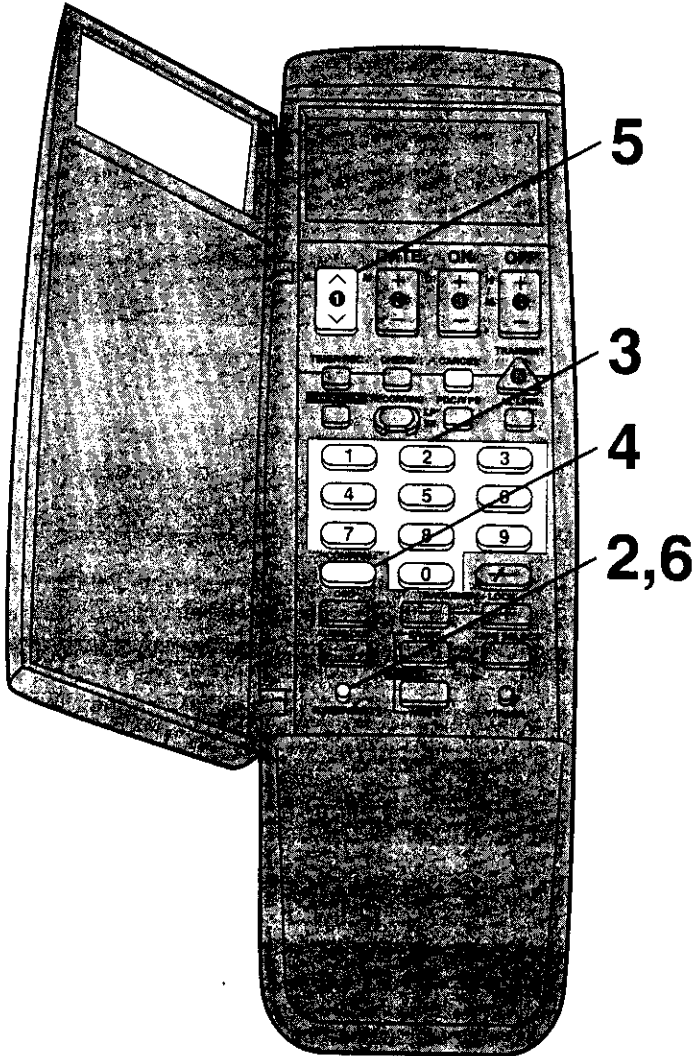

### Operations

### Display Symbols

- 1 Open the door of the remote controller.

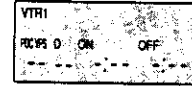

- 2 Keep **CLOCK/PRESET** pressed for more than 2 seconds and then press it again.



- 3 Enter a ShowView number.  
Example: 744286

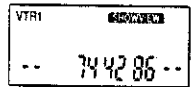

• If you have entered the wrong number, press **CANCEL** and then enter the proper number.

- 4 Press **CONFIRM** to set the guide number.



- 5 Select the programme position (1-99, A1-A3).



• To set the other TV stations, repeat steps 3 to 5.

- 6 Press **CLOCK/PRESET** twice.

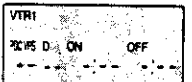

- 7 Close the door of the remote controller.

**Note:**

Enter ShowView numbers which are ahead of the present time. Otherwise, they will not be set into the proper guide numbers.

# Setting the Remote Controller for Operation of your TV

You can operate some manufacture of TVs (see table below) using the supplied remote controller after this setting up.

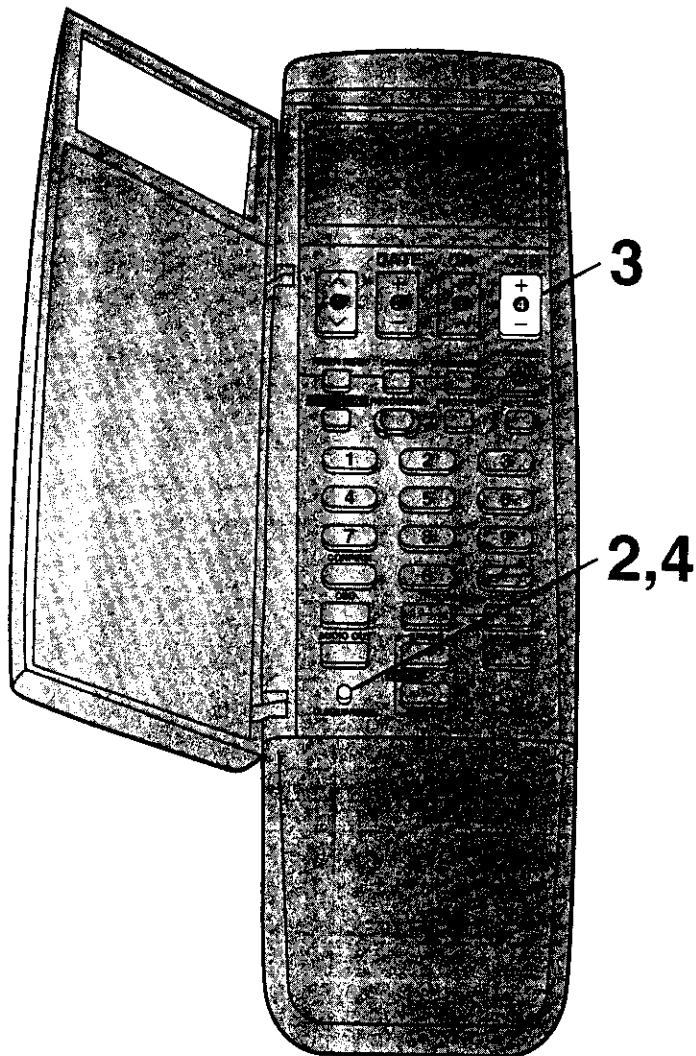

## Preparation

- Turn on the TV.
- Install the batteries in the remote controller.

## Operations

## Display Symbols

- 1 Open the door of the remote controller.



- 2 Keep **CLOCK/PRESET** pressed for more than 2 seconds and then press it twice.

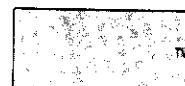

- "TV" now appears on the remote controller's display.

- 3 Press **OFF** several times.

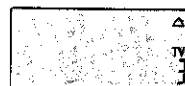

- When the number matches the manufacturer of your TV, the TV's power is turned off.

- 4 Press **CLOCK/PRESET**.

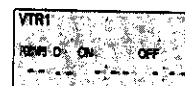

- 5 Close the door of the remote controller.

### When the number is 1, 2, 3 or 4:

When the TV's power is turned off in step 3 above, turn it back on and adjust the TV's volume using this remote controller. The volume can be adjusted if the number matches the manufacturer of TV. If it is not possible to adjust the TV's volume, try setting the number (1 to 4) to match the manufacturer of TV again until the volume can be adjusted.

### Note:

Some TV models cannot be operated using this remote controller.

Number	Manufacturer
1	Panasonic
2	
3	
4	
5	GRUNDIG/Blaupunkt
6	PHILIPS
7	SONY



## Power Source for the Remote Controller

The remote controller is powered by 2 "UM3" or "R6" size batteries. The life of the batteries is about one year, although this depends on the frequency of use.

### Precautions for Battery Replacement

- Load the new batteries with their polarity ( $\oplus$  and  $\ominus$ ) aligned correctly.
- Do not apply heat to the batteries, or an internal short-circuit may occur.
- If you do not intend to use the remote controller for a long period of time, remove the batteries and store them in a cool and dry place.
- Remove spent batteries immediately and dispose of them.
- Do not use an old and a new battery together, and never use an alkaline battery with a manganese battery.

### Installing the Batteries

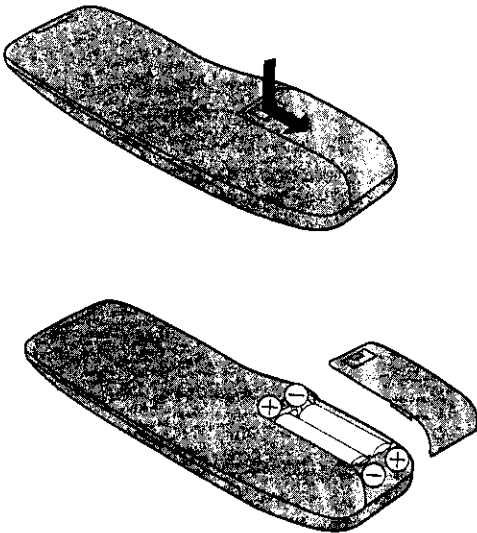

# Initial Settings Using On Screen Displays

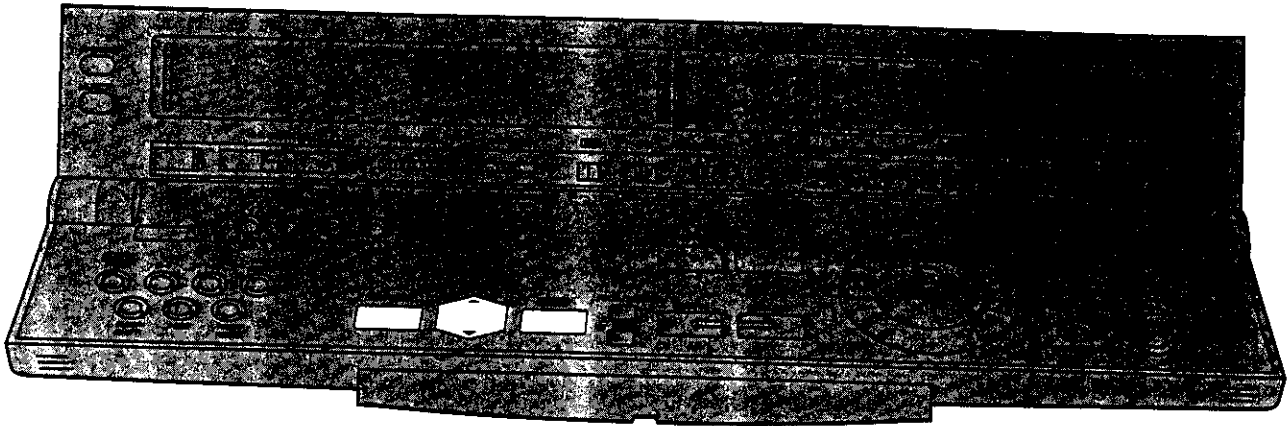

## Preparation

- Confirm that the TV is on and the VTR viewing channel is selected.
- Turn on the VTR.

1 Press **EDIT MENU**.



2 Select **SETTING**.



### On Screen Display

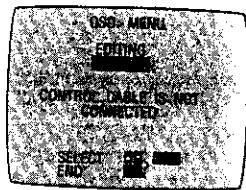

3 Press **ENTER**.

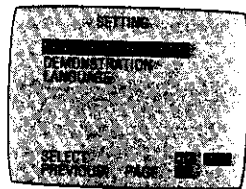

## To select the Desired Language

Select one of the seven languages displayed: English, German, French, Italian, Spanish, Dutch and Swedish. Follow steps 1 to 3 of the above procedure.

4 Select **LANGUAGE**.

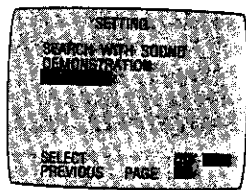
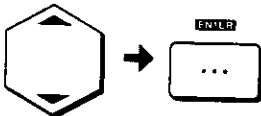

5 Select the desired language.

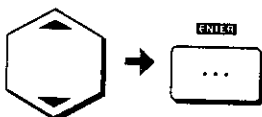

## To select Sound Setting

Follow steps 1 to 3 of the above procedure.

4 Select **SEARCH WITH SOUND**.

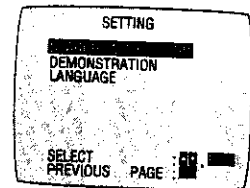
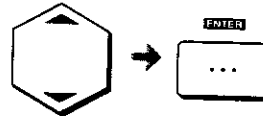

5 Select the desired setting.

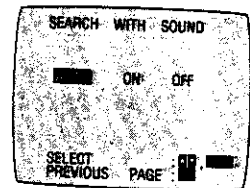
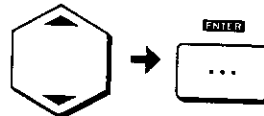

- AUTO:** The sound can be heard during special playback only when an editing operation is in progress.
- ON:** The sound can be always heard during special playback.
- OFF:** The sound can not be heard during special playback.

## To View a Demonstration

Follow steps 1 to 3 of the above procedure.

4 Select **DEMONSTRATION**.

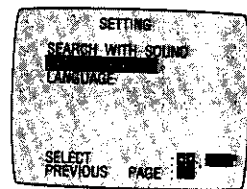
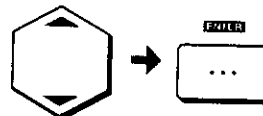

- The On Screen Displays for editing are displayed one after the other at about five second intervals.

## Optional Function

### VITC (Vertical Interval Time Code) Function

As an address (individual number) is recorded for each frame, it is possible to find the accurate position of any desired scene or picture on a tape by checking the address during playback. This address is called "Time Code". Since the VITC signals (Vertical Interval Time Code) are recorded together with the picture signals, they will not be cancelled even when the video cassette is taken out from the VTR or the VTR is switched off. This makes it possible to check the precise position of any desired picture at any time.

- The VITC function becomes operative when the VTR is equipped with the optional VITC adaptor. Consult your authorized video dealer.

Follow steps 1 to 3 of the above procedure.

#### 4 Select **EDITING WITH VITC**.

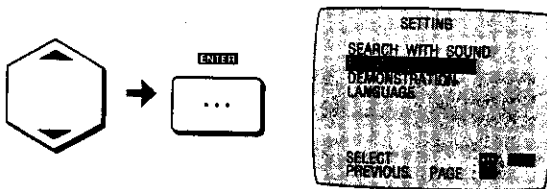

#### 5 Select the desired setting.

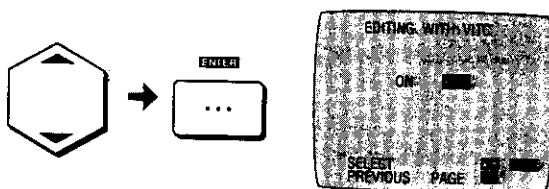

- ON:** For reading the VITC signals during playback and writing them during recording. The time code is indicated on the counter in increments of hours, minutes and seconds. During programme editing, it appears on the screen in increments of hours, minutes, seconds and frames (25 frames per second).
- OFF:** The normal counter is displayed.

#### Reading the VITC signals

"-:--:--" appears on the counter when the cassette is inserted. When playback is started, the VITC signals are read and the time code is displayed.

- When VITC signals have not been written on the tape, the time code is not displayed.

#### Writing the VITC signals

"-:--:--" appears on the counter when the cassette is inserted. When recording is started, the VITC signals are written starting at 0h00m00s00f.

If recording is started after the tape has been played back and the VITC signals read, the VITC signals will be written following on from the time code which is displayed on the counter at that time.

#### Notes:

- To use the VITC function to edit, be sure to first turn on the VITC function with the procedure described above, then begin editing after cancelling all editing programmes used last time.
- When tracking is out of adjustment, the VITC signals may not be properly read.
- The counter cannot be reset when the VITC function is on. This is because the VITC signals are recorded on the tape.
- When the VITC function is on, up to 50 scenes can be programmed in the programme assemble editing mode. If the VTR is not equipped with the optional VITC adaptor, a maximum of 10 scenes can be programmed using the counter.
- To make optimal use of the advantages offered by the VITC function during editing, this VTR should be connected to another NV-HS1000 also equipped with the VITC function. When this VTR is to be connected to another unit which is not equipped with the VITC function, the editing precision will be increased if the NV-HS1000 is used as the playback VTR.

# Playback

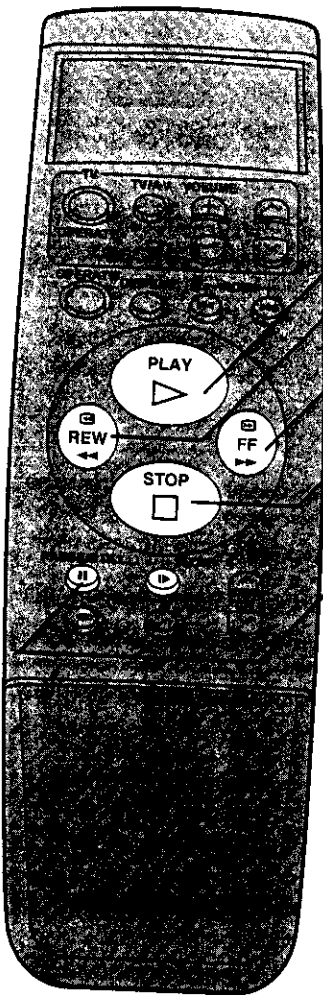
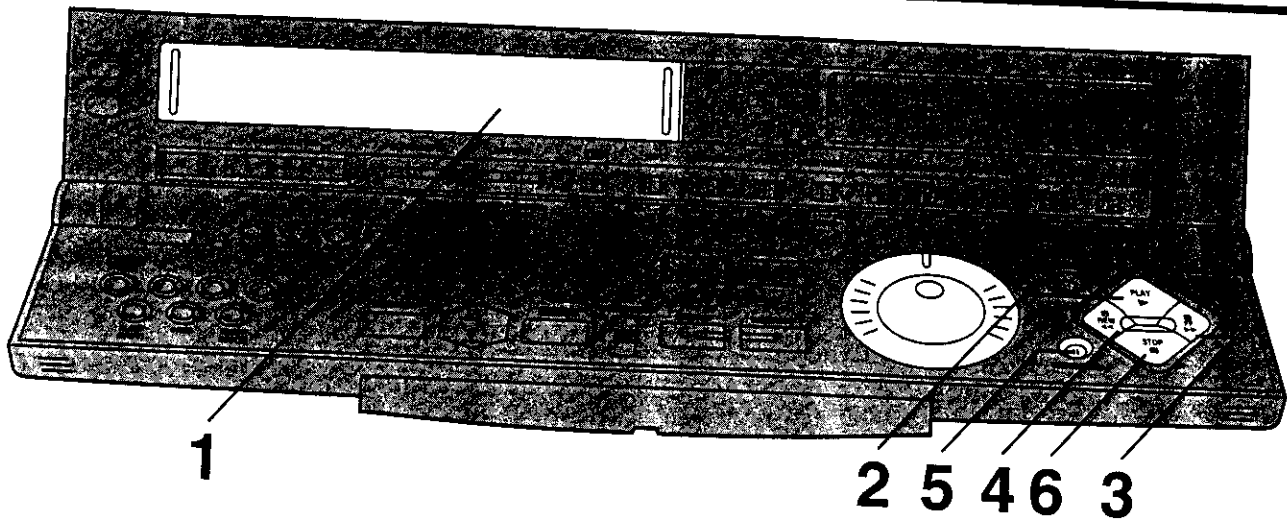

## Operations

## Display Symbols

- |   |  |  |   |
|---|--|--|---|
| 1 |  |  | Insert a recorded cassette tape.  |
| 2 |  |  | Start viewing the picture.  |
| 3 |  |  | Search forward by tapping <b>FF</b> .<br>• To change back to normal playback, press <b>PLAY</b> .     |
| 4 |  |  | Search backward by tapping <b>REW</b> .<br>• To change back to normal playback, press <b>PLAY</b> .   |
| 5 |  |  | View a still picture.<br>• To continue the normal playback, press <b>PLAY</b> or <b>PAUSE/STILL</b> . |
| 6 |  |  | Stop viewing the picture.   |

## Other Playback Functions

### To change the Playback Speed

#### Using Shuttle Ring:

- 1 Press **PAUSE/STILL** on the VTR.
- 2 Rotate Shuttle Ring.

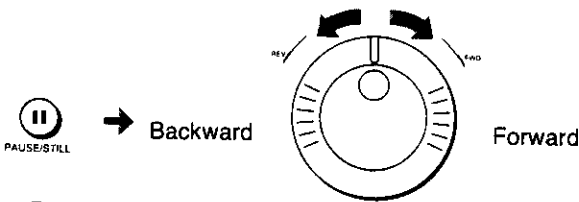

#### Note:

- Audio reproduction of linear (conventionally recorded) tapes will be monaural when played back on the FM Hi-Fi video recorders.
- Cue or review playback will be automatically released after 10 minutes, and still or slow playback after 5 minutes.

#### Using Remote Controller:

Press **SLOW** during playback to activate slow playback.



### To locate the Desired Picture exactly

- 1 Press **PAUSE/STILL** on the VTR.
- 2 Turn Jog Dial.

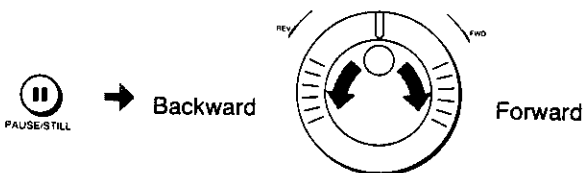

### To obtain High Speed Picture during Fast Forward or Rewind

Keep **FF** pressed during fast forward.  
Keep **REW** pressed during rewind.

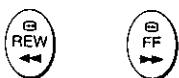

# On-the-spot Recording

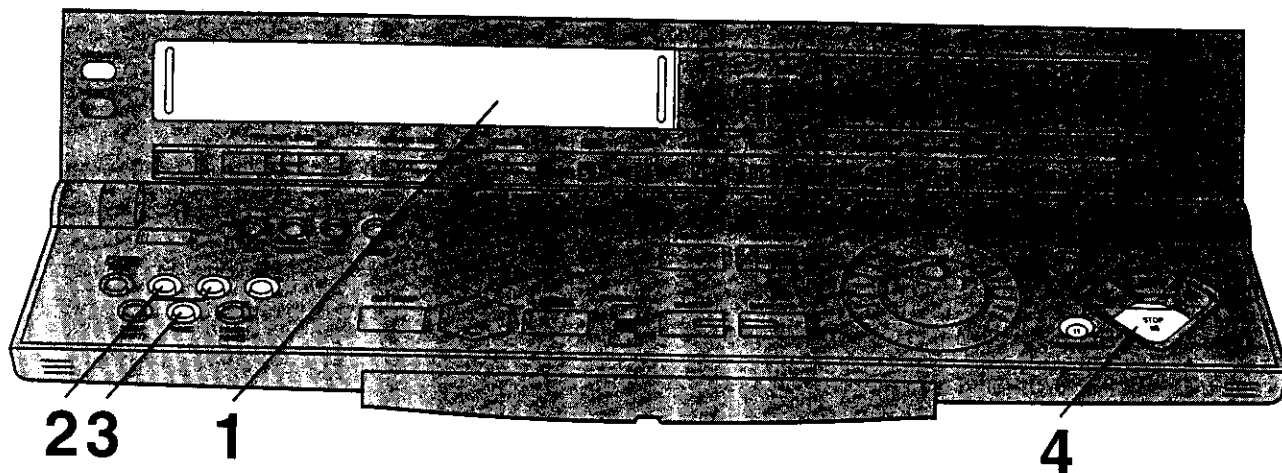

Operations	Display Symbols	
<b>1</b> 		Insert a cassette tape. • If it has already been inserted, press <b>OPERATE</b> to turn the VTR on.
<b>2</b> 		Select TV station.
<b>3</b> 		Start recording.
<b>4</b> 		Stop recording.

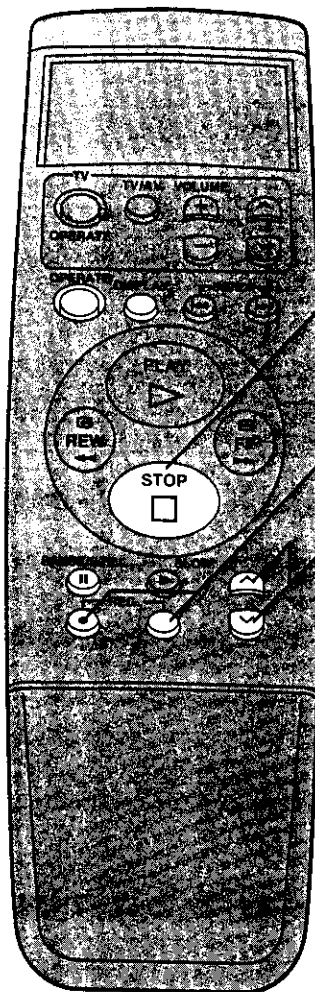

### To select the Desired Tape Speed

Press **SP/LP** before recording.



### To interrupt Recording

Press **PAUSE/STILL** during recording.

Press again to continue recording.

PAUSE/STILL



### To record One TV Programme while Viewing Another Programme

- 1 Refer to the on-the-spot recording operations steps 1 to 3.
- 2 Select the TV programme on your TV set you wish to view at the present time.

### To display the Approximate Remaining Tape Time

- 1 Press **TAPE SELECT** to select the corresponding cassette tape length.

TAPE SELECT



E195: For E30, -60, -90, -120, -180 and -195 tapes

E240: For E240 tape

E260: For E260 and -300 tapes

- 2 Press **DISPLAY**.

DISPLAY



→Clock→Counter→Remaining Tape Time→

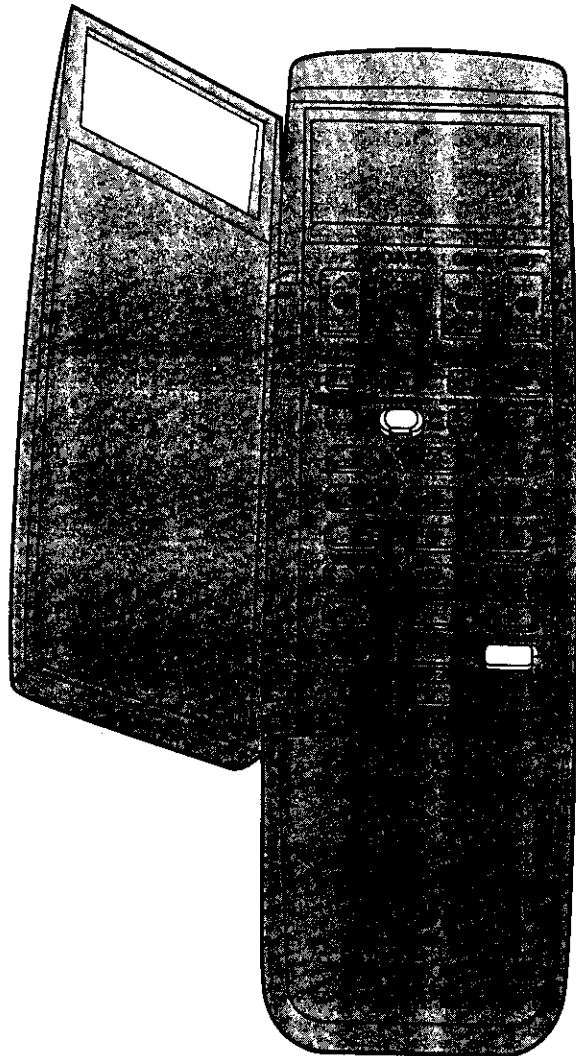

#### Notes:

- When a video cassette with a broken off tab is inserted, the "CD" indication will flash to indicate that recording is not possible.
- The recording pause mode will be automatically released after 5 minutes, and be back to the stop mode.

# Timer Recording

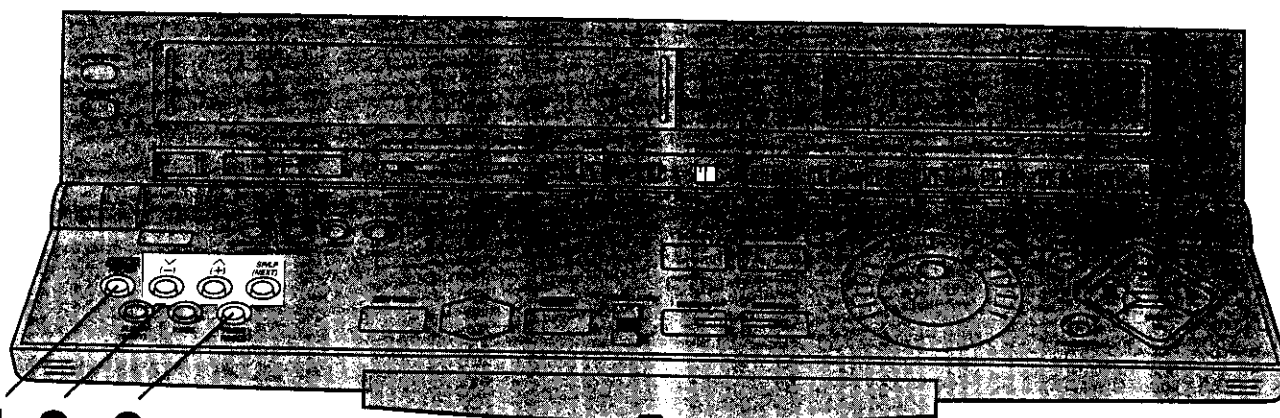

**1 2 3**

Up to 8 timer programmes can be recorded up to one month in advance by setting the timer, including daily and weekly programmes.

## Preparation











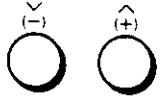

Insert a cassette tape with an intact erasure prevention tab.

## For Example:

Timer programme number; 1  
 Programme position (channel); 2  
 Date; 27th, October  
 Starting time; 20:02  
 Ending time; 21:30  
 (present date; 16th October)

## Operations

## Display Symbols

- |  |   |  |
|--|---|--|
| <p><b>1</b></p>    |  | <p>Select Timer programme number "1".</p>  |
| <p><b>2</b></p> <p>Set each item by pressing <math>\wedge</math> (+) or <math>\vee</math> (-) and <b>SP/LP (NEXT)</b>.</p>  |  | <p>Set Programme position (channel) "2".</p>   |
|  |  | <p>Set Date "27".<br/>                 •For daily and weekly recording, see next page.</p>                 |
|  |  | <p>Set Starting time (hour) "20".</p>  |
|  |  | <p>Set Starting time (minute) "02".</p>  |
|  |  | <p>Set Ending time (hour) "21".</p>  |
|  |  | <p>Set Ending time (minute) "30".<br/>                 •There is no need to press <b>SP/LP (NEXT)</b>.</p> |
| <p><b>3</b></p>                          |  | <p>To activate timer recording, press <b>TIMER REC</b>.</p>  |



## Setting for Daily and Weekly Timer Recording

In the Date setting step, press  $\nabla$  (-) repeatedly until the desired day (days) is displayed.

### Daily recording

From Sunday to Saturday



From Monday to Saturday



From Monday to Friday



### Weekly recording

For example, Sunday



## Timer Recording from External Signal Source

If Timer Recording is performed by a unit connected to the AV1/AV2 Socket or the Audio/Video/S-Video input sockets, select the A1, A2 or A3 indicator for the programme position.

A1: Through the AV1 socket

A2: Through the AV2 socket

A3: Through the AV3 sockets on front panel

Set **INPUT SELECT** on the VTR.

S-VIDEO: Through the S-VIDEO IN and AUDIO IN sockets

LINE: Through the VIDEO IN and AUDIO IN sockets

## Selecting the Desired Tape Speed

After step 2, press **SP/LP (NEXT)** and select SP or LP by pressing  $\wedge$  (+) or  $\nabla$  (-).

## Setting other Programmes in Succession

Repeat steps 1 and 2.

## Checking a Timer Programme

Select the timer programme number to be checked by pressing **CHECK/PROG**.

CHECK  
PROG



### On Screen Display

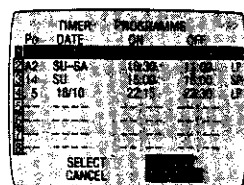

## Cancelling a Timer Programme

- 1 Press **TIMER REC** to turn off the timer recording function.
- 2 Select the timer programme number to be canceled by pressing **CHECK/PROG**.
- 3 Press  $\wedge$  (+) and  $\nabla$  (-) simultaneously for more than 3 seconds.

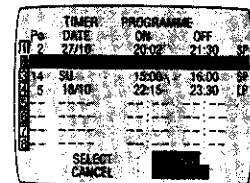
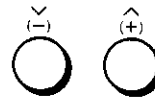

## Optional Function

### PDC (Programme Delivery Control)/VPS (Video Programme System)

The Programme Delivery Control (PDC) or the Video Programme System (VPS) is a very convenient system which assures that the TV programmes you have programmed for timer recording will be recorded exactly from beginning to end, even if the actual broadcasting time differs from the scheduled time due to delayed start or extension of the programme duration. Also, if a programme is interrupted and, for example, some special news are inserted, the recording will also be interrupted automatically and resumed when the programme continues.

- This model is equipped with PDC/VPS function. The PDC/VPS function becomes operative when the VTR is equipped with the optional VPS/PDC decoder. Consult your authorized video dealer.
- Press **SLEEP (SHIFT)** in step 2 to cancel the PDC/VPS function.
- In the case of PDC/VPS recording, use the **correct** time (PDC/VPS time) for recording the TV programmes. PDC/VPS recording is not performed when the time (PDC/VPS time) is incorrect, even if only by one minute.
- If the actual broadcasting times of timer recordings overlap (regardless of whether they are PDC/VPS controlled), the recording that starts first has always priority, and the recording of the later beginning programme will start only after the first timer recording has finished.
- When the PDC/VPS signal drops out because the broadcast signal is weak, or when a broadcasting station does not transmit a regular PDC/VPS signal, the timer recording will be performed in the normal mode (without PDC/VPS) even if it was programmed for PDC/VPS. In this case, even if the timer recording is performed, whatever has been programmed will not be cancelled at that particular time but at 4 a.m. on the following day.

### Note:

If a timer recording is not performed to the end (due to insufficient tape or cancellation by the user), the programmed timer recording data will be cancelled from the memory by 4 a.m. two days later.

However, if the Timer Record Function is activated at that time, the programmed timer recording data will be cancelled at 4 a.m. the next day.

# Using the Remote Controller

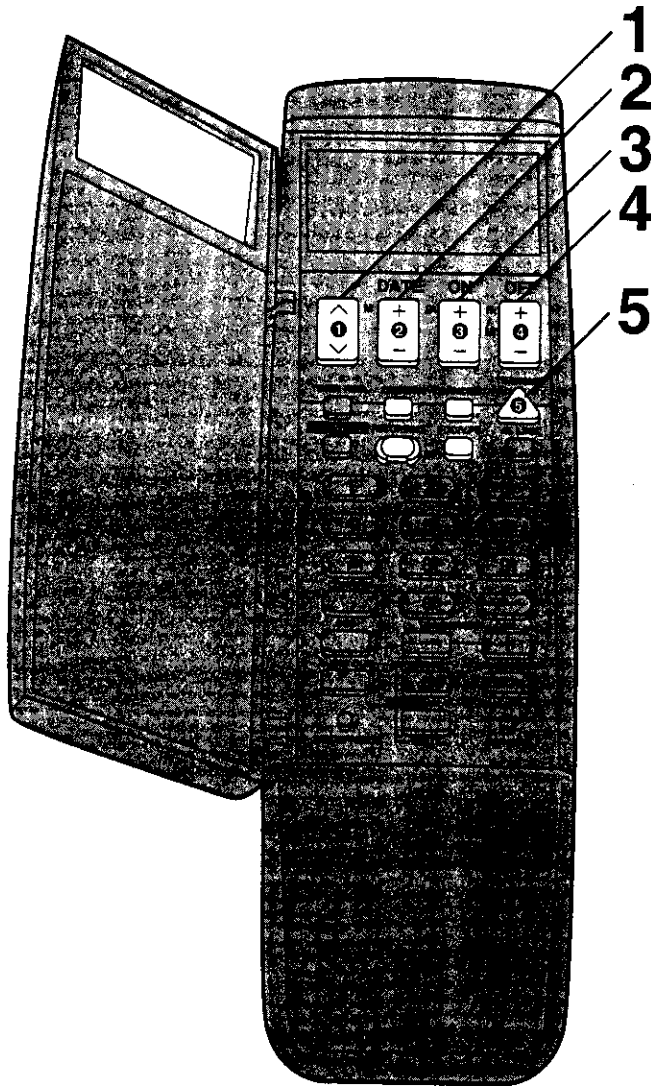

## Preparation

- Insert a cassette tape with an intact erasure prevention tab.
- Open the door of the remote controller.

## For Example:

Programme position (channel); 2  
 Date; 27th, October  
 Starting time; 20:02  
 Ending time; 21:30

## Operations

## Display Symbols

**1** Set Programme position (channel) "2".

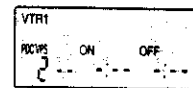

**2** Set Date "27".

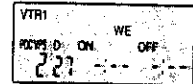
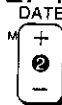

**3** Set Starting time "20:02".

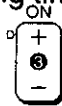

- When it is kept pressed, the indication changes in 30-minute steps.

**4** Set Ending time "21:30".

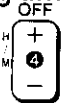

**5** Press TRANSMIT.



## On Screen Display

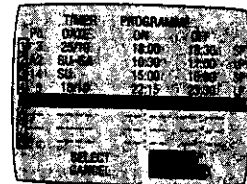

**6** Close the door of the remote controller.

### Daily Timer Recording

For this timer function, several groups of days can be selected.

- (A) Daily recording from Sunday to Saturday
- (B) Daily recording from Monday to Saturday
- (C) Daily recording from Monday to Friday

In step 2, select the desired days by pressing **DATE** —. For Example, (A)



### Weekly Timer Recording

In step 2, select the desired day by pressing **DATE** —. For example, SU (Sunday)



### Timer Recording from External Signal Source

If Timer Recording is performed by a unit connected to the AV1/AV2 Socket or the Audio/Video/S-Video input sockets, select the A1, A2 or A3 indicator in step 1 for the programme position.

- A1: Through the AV1 socket
- A2: Through the AV2 socket
- A3: Through the AV3 sockets on front panel

Set **INPUT SELECT** on the VTR.

**S-VIDEO:** Through the S-VIDEO IN and AUDIO IN sockets

**LINE:** Through the VIDEO IN and AUDIO IN sockets



### Selecting the Desired Tape Speed

Press **RECORDING SP/LP** in any of steps 2-4.



### Turning PDC/VPS Function On and Off

Press **PDC/VPS** in any of steps 2-4.



### Checking a Timer Programme

- The VTR must be turned on, or the timer recording indicator "☐" is lit.

Press **CHECK**.



#### On Screen Display

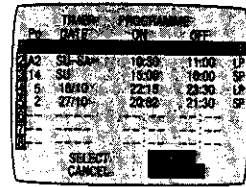

### Cancelling a Timer Programme

- The VTR must be turned on, or the timer recording indicator "☐" is lit.

1 Press **CHECK** repeatedly to select the desired timer programme number.

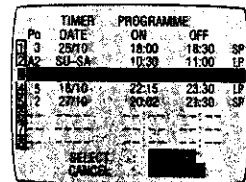

2 Press **CANCEL**.

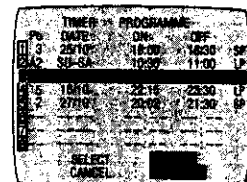

# ShowView Programming

Programming is now easier than ever: simply enter the ShowView number provided in the programme schedule column carried by newspapers and magazines. ShowView numbers are numbers which are assigned to each programme listed in the TV programme schedule carried in newspapers and TV guides. When these numbers are entered and **TRANSMIT** is pressed, the numbers are converted into the actual programming and sent to the VTR.

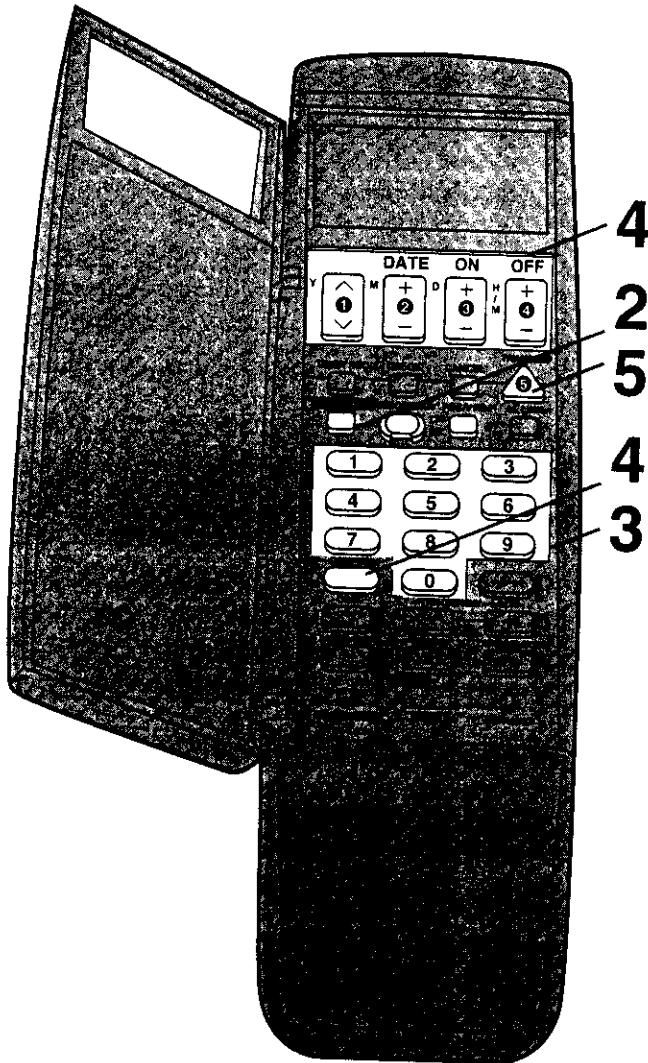

## Preparation

- Insert a cassette tape with an intact erasure prevention tab.
- Set the programme positions on both the VTR and remote controller as shown on pages 12–15.

## Operations

## Display Symbols

- 1 Open the door of the remote controller.

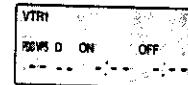

- 2 Press **SHOWVIEW**.

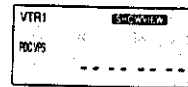

- 3 Enter a ShowView number.  
Example: 920216

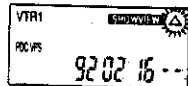

- 4 Press **CONFIRM** to check that the number corresponds to the right programme.

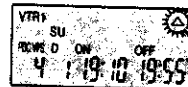

- To make any corrections, use buttons 1–4.

- 5 Press **TRANSMIT**.

## On Screen Display



Po	TIMER		PROGRAMME		SP
	DATE	ON	OFF		
3	25/10	18:00	18:30	SP	
A2	SU-SA	10:30	11:00	LP	
5	SU	15:00	18:00	SP	
5	18/10	22:15	23:30	LP	
2	27/10	20:02	21:30	SP	

SELECT  
CANCEL

- 6 Close the door of the remote controller.

## Notes:

- To select the desired tape speed, press **RECORDING SP/LP** in any of steps 3–4.
- To cancel the PDC/VPS function, press **PDC/VPS** in any of steps 3–4.
- When the ShowView number is used for programming, the recording time may be slightly longer than the actual programme time.
- Repeat steps 2 to 4 if "Err" appears on the remote controller.
- When programming two or more programmes, repeat steps 2 to 5.
- The procedures for checking and cancelling whatever has been programmed are the same as for remote control programming.

# Other Functions

Timer Recording  
Other Functions

## VHS Index Search System

It is very easy to find the beginning of each recording, because a special index signal is recorded at the start of each recorded segment on the tape.

### For example:

Searching for the 2nd recorded segment in the forward direction.

Press **INDEX**  $\blacktriangleright\blacktriangleright$  twice.



- After finding the specific recorded segment, playback starts automatically.
- For the reverse direction, press **INDEX**  $\blacktriangleleft\blacktriangleleft$ .
- Up to 20 programmes can be searched for in both directions.

### Recording Index Signals

Index signals are recorded in following cases. **WRITE** indicator appears on the Display.

- When a recording is started by pressing **REC**.
- When **REC** is pressed during recording.
- When timer recording is activated.
- When **WRITE** is pressed during playback.

### Erasing Index Signals

- 1 Search the Index signal to be erased by pressing **INDEX**  $\blacktriangleright\blacktriangleright$  or  $\blacktriangleleft\blacktriangleleft$ .
  - Be sure not to omit this step. Otherwise, this function may not work correctly.
- 2 Press **PAUSE/STILL** when playback starts.
- 3 Press **ERASE**.
  - Erasing is possible during playback if **ERASE** is pressed during the five seconds following the index signal.

### Notes:

- The index search function can only work correctly, if the index signals are spaced at least 3 minutes apart in the SP mode and 5 minutes apart in the LP mode.
- Index signals can not be recorded or erased on a video cassette with a broken off tab.

### On Screen Display

Press **OSD** to make the On Screen Display appear on the TV screen.

• To make this display disappear, press **OSD** again.

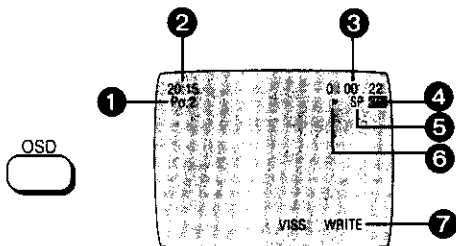

### Note:

On Screen Display will not appear during NTSC playback.

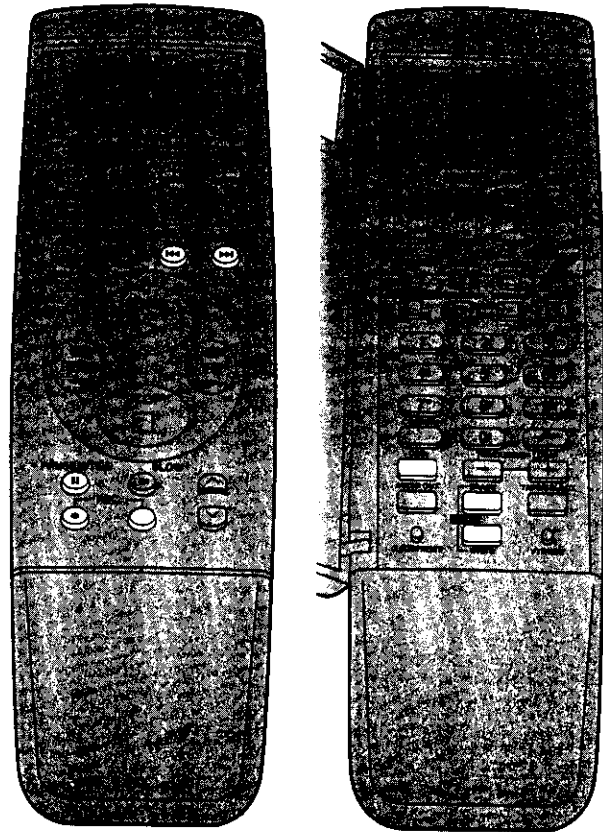

- 1 Programme position
- 2 Present time
- 3 Tape counter
- 4 Cassette-in indicator
- 5 Tape speed indicator
- 6 Tape running display

Stop, Eject	■
Rewind, Review	◀◀
Fast Forward, Cue	▶▶
Playback	▶
Reverse Playback	◀
Still Playback	
Recording, Insert, Audio Dubbing	●
Recording Pause, Insert Pause, Audio Dubbing Pause	●
Slow Playback	▶▶▶
Reverse Slow Playback	◀◀◀

- 7 Index signal writing or erasing indicator

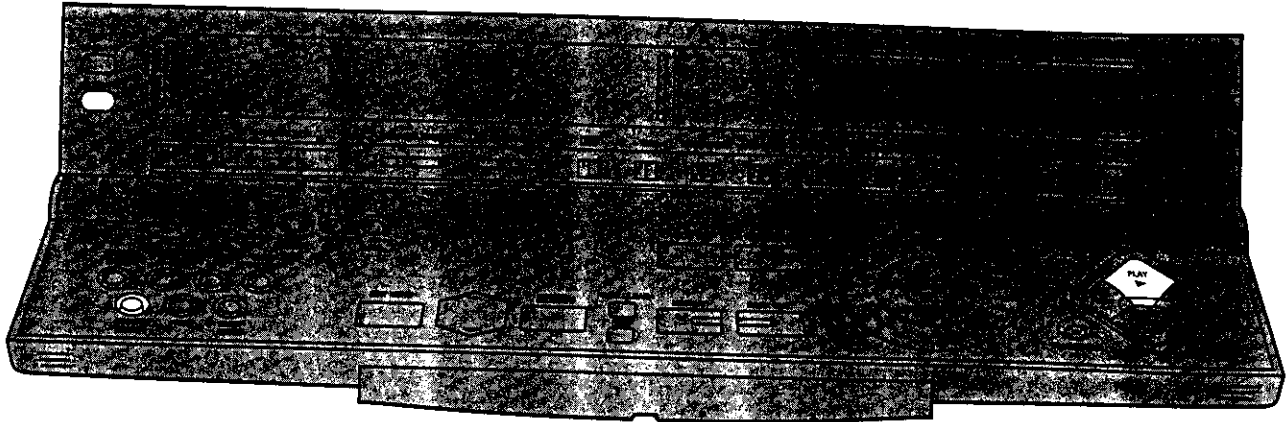

### Automatic VTR Off Time Setting

Press **SLEEP** for the desired time.



- Each press gives a 30 minutes time span up to 9 hours.
- To cancel the setting time, press **SLEEP** repeatedly to set 0:00.

### NTSC Playback

Tapes recorded in the NTSC system can be played back with this VTR via a PAL system TV set.

- The playback picture may roll up or down. If the TV set is equipped with a V-HOLD control, it may be possible to stop the picture movement by adjusting this control.
- Depending on the TV set used, the picture may be in black and white. However, this is not an indication of a malfunction.

### Other Automatic Functions

#### Automatic Playback

When a cassette without an erasure prevention tab is inserted, the VTR starts playback automatically.

#### VTR-off Playback

When the VTR is off, an inserted cassette can be played back by pressing **PLAY**.

#### Automatic Rewinding

When the tape reaches its end during recording (except for timer recording) or playback, it will automatically be rewound to the beginning.

#### Automatic Switching Off and Ejection

When the VTR is switched off, an inserted cassette can be ejected simply by pressing **EJECT**. The VTR will eject the cassette and automatically turn itself off again.

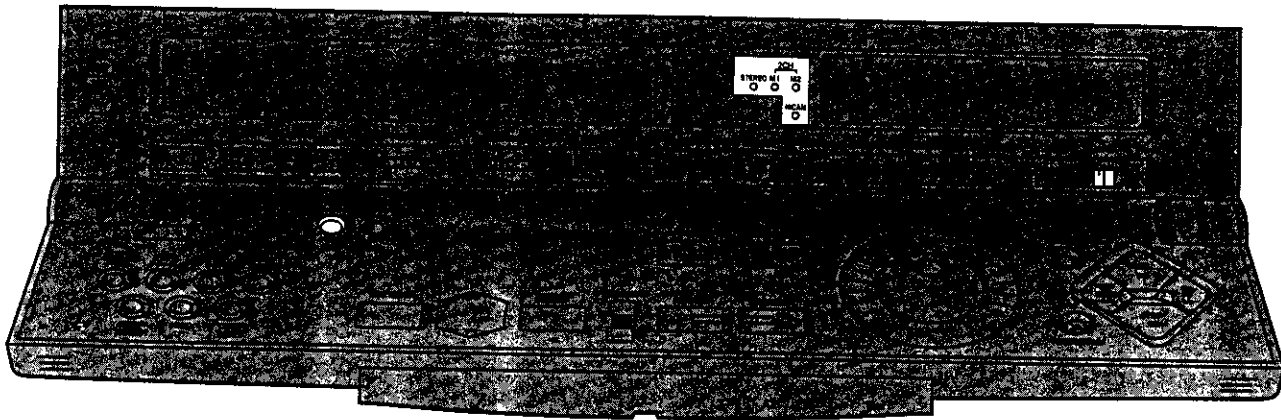

## Hi-Fi Audio System

This VTR is equipped for reception of stereo/bilingual broadcasts both in the NICAM stereo/bilingual sound system employed in the Scandinavia, etc. and in the Stereo/bilingual sound system used in Germany and other Central European countries.

NICAM is a 2 Channel sound broadcast system to provide either a high quality stereo sound track or 2 independant MONO sound tracks, M1 and M2.

NICAM programmes are always accompanied by standard sound broadcasts and you can select the desired sound with **MONO** (when recording) or with **AUDIO OUT** (when playback).

The NICAM digital stereo sound can only be recorded on the Hi-Fi audio track.

When a stereo, bilingual or NICAM programme is being received, the indicators are lit to inform you of the type of broadcast.

### Reception of a Stereo Broadcast

When the STEREO indicator is lit, set **MONO** to OFF to be able to record on the Hi-Fi sound track stereo.

### Reception of a Bilingual Broadcast

When the M1 and M2 indicators are lit, set **MONO** to OFF if you want to record both channels on the Hi-Fi sound track. M1 is the main channel and M2 is the sub channel.

### Reception of a NICAM Stereo Broadcast

When the NICAM and STEREO indicators are lit, set **MONO** to OFF to be able to record on the Hi-Fi sound track in stereo.

### Reception of a NICAM Dual-Sound Broadcast

When the NICAM, M1 and M2 indicators are lit, set **MONO** to OFF if you want to record both channels on the Hi-Fi sound track. M1 is the left-hand channel and M2 is the right-hand channel.

### Reception of a NICAM Monaural Broadcast

When a NICAM monaural broadcast is being received, the NICAM and M1 indicators are lit. To hear such a signal on both channels and to record it on both channels of the Hi-Fi track, set **MONO** to OFF.

- To record the regular sound (ordinary normal sound) on the FM audio tracks when a Stereo, Bilingual or NICAM programme is received, set **MONO** to ON.

### Important Note for the NICAM System

When this VTR tuner is switched on, it will automatically switch to a NICAM broadcast, if NICAM is being transmitted. During test transmissions, it is possible that the sound received doesn't correspond to the picture being viewed. In order to receive a synchronized sound and picture, select monaural sound with either **AUDIO OUT** or with **MONO**. This will only apply until NICAM transmissions are fully operational.

At this time the NICAM signal is transmitted on stereo channels only, since the M1 and M2 formats are not yet available. Even if the soundtrack is in MONO, the stereo indicator will remain illuminated.

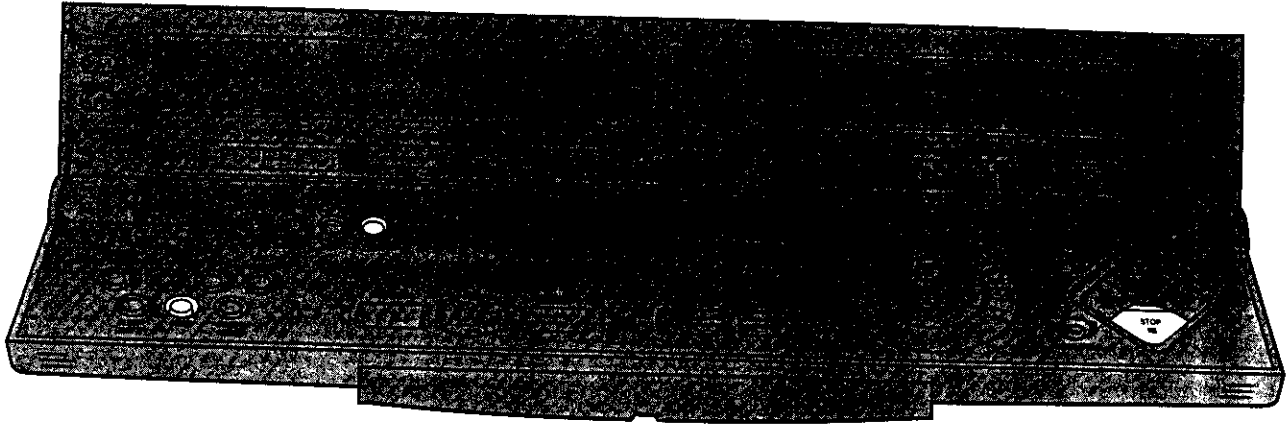

## Pay TV

The connection of a Pay TV (e.g. Canal Plus, Filmnet) Decoder to the AV2 Socket of this VTR makes it possible to record Pay TV broadcasts. When such a decoder is connected to the VTR, it is also possible to watch Pay TV programmes directly on the connected TV set. So only one decoder is necessary. See page 7.

### Preparation

- Turn on the VTR, the Pay TV Decoder and the TV set.
- Insert a video cassette with intact erasure prevention tab.
- The VTR must have been preset for reception of Pay TV broadcasts like for any ordinary TV station as described in "Storing TV Broadcasts into your VTR" on page 12.

### To Record a Pay TV Programme While Watching the Same Pay TV Programme

- 1 Press **AV LINK** to select the VTR mode.
- 2 Select the desired Pay TV station.
- 3 Press **REC** to start recording.
- 4 Press **STOP** to stop recording.

### To Record a Normal TV Programme While Watching a Pay TV Programme

- 1 Press **AV LINK** to select the TV mode.
- 2 Select on the VTR the normal TV station that you want to record.
- 3 Press **REC** to start recording.
- 4 Select on the TV set the desired Pay TV station for watching.
- 5 Press **STOP** to stop recording.

### To Record a Pay TV Programme While Watching a Normal TV Programme

- 1 Press **AV LINK** to select the TV mode.
- 2 Select on the VTR the Pay TV station that you want to record.
- 3 Press **REC** to start recording.
- 4 Select on the TV set the desired normal TV station for watching.
- 5 Press **STOP** to stop recording.



This VTR is equipped with programme editing functionality. If connected via edit cable to another VTR or a movie camera, it is possible to control such functions as tape playback and editing.

## Connections

### Connecting This VTR with Another Identical One

- Connect the two VTRs with an edit cable.
- Connect the AV1 socket on the recording VTR to the TV.
- Connect the AV1 socket on the playback VTR to the AV2 socket on the recording VTR.
- Select A2 by pressing  $\wedge \vee$  on the recording VTR.
- Set **EDIT MODE** to **PASSIVE** on the playback VTR, and to **RECORDER** on the recording VTR.
- Control is performed by the recording VTR.

### Using This VTR as the Recording VTR

- Connect this VTR to the playback unit with an edit cable.
- Connect the AV1 socket on this VTR to the TV.
- Connect the AV2 socket or the AUDIO/VIDEO/S-VIDEO IN (AV3) sockets on this VTR to the playback unit.
- Select A2 or A3 by pressing  $\wedge \vee$  on this VTR.
  - A2: Through the AV2 socket
  - A3: Through the AV3 sockets on front panel
- Set **INPUT SELECT** on this VTR.
  - S-VIDEO: Through the S-VIDEO IN and AUDIO IN sockets
  - LINE: Through the VIDEO IN and AUDIO IN sockets
- Set **EDIT MODE** on this VTR to **RECORDER**.
- Control is performed by this VTR.

### Using This VTR as the Playback VTR

- Connect this VTR to the recording unit with an edit cable.
- Connect the AV1 socket on this VTR to the TV.
- Connect the AV2 socket on this VTR to the recording unit.
- Select A2 by pressing  $\wedge \vee$  on this VTR.
- Set the input switch on the recording unit to AV.
- Set **EDIT MODE** on this VTR to **PLAYER**.
- Control is performed by this VTR.

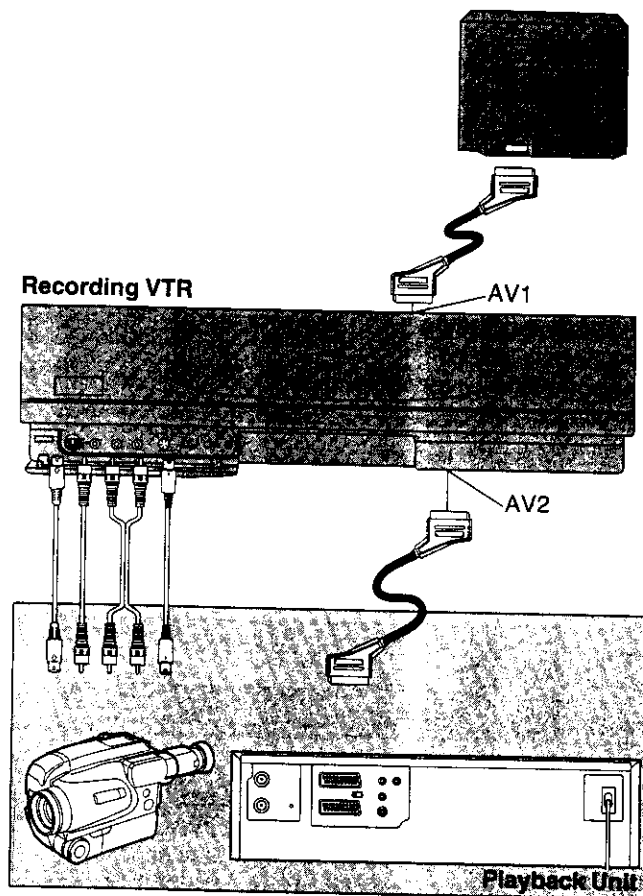

#### Notes:

- When connecting a VTR or movie camera which does not have an edit socket, see page 50.
- During editing operations, operate using this VTR; do not operate the other unit.
- When this VTR is used as the playback VTR, it may not be possible to perform editing operations properly depending on the type of the recording VTR. In such a case, use this VTR as the recording VTR.
- When a movie camera is connected, operating this VTR will not facilitate reverse playback or reverse slow playback on the movie camera.
- When **EDIT MODE** on this VTR is set to **PASSIVE**, operation will not be possible, and the On Screen Display will not appear.
- When making a connection using an edit cable, disconnection of the AC mains lead on this VTR may result in erroneous display patterns on the other unit.
- When operating the Jog Dial and Shuttle Ring, it is only possible to reset the tape counter of the other unit during still playback.
- The supplied edit cable cannot be used to connect two other VTRs with edit sockets.
- The On Screen Display does not appear when no input signals are supplied from another unit or when a non-recorded cassette is played.
- The On Screen Display may appear distorted if the picture is affected by noise.

# Editing Functions

Using this VTR, 4 types of manual editing and 4 types of programme editing can be selected.  
 In programme editing, after programming up to 10 scenes for each type, editing can be performed automatically.

## Manual Editing

- Copying
- Insert Editing
- AV Insert Editing
- Audio Dubbing

## Programme Editing

- Assemble Editing
- Insert Editing
- AV Insert Editing
- Audio Dubbing

## Copying

Allows the re-recording (copying) of the picture and sound from one tape onto another tape.

### Playback VTR



### Recording VTR



## Insert Editing

Allows the partial replacement of the picture and Hi-Fi sound on a recorded tape. Normal sound is left in its original state.

### Playback VTR



### Recording VTR

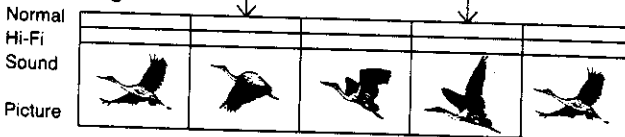

### Edited Tape

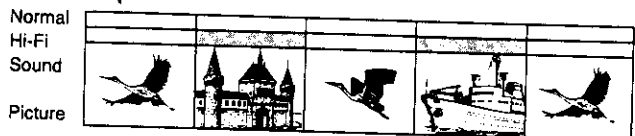

- To hear the original sound, select the normal sound track by pressing **AUDIO OUT**.
- To hear the new sound and original sound mixed together, set **HI-FI/NORMAL MIX** to ON.

### AV Insert Editing

Allows the partial replacement of the picture and both the Hi-Fi and normal sound on a recorded tape.

#### Playback VTR



#### Recording VTR



#### Edited Tape



### Audio Dubbing

Allows the partial replacement of the normal sound on a recorded tape. Hi-Fi sound is left in its original state.

#### Playback VTR



#### Recording VTR



#### Edited Tape



- To hear the new sound, select the normal sound track by pressing **AUDIO OUT**.
- To hear the new sound and original sound mixed together, set **HI-FI/NORMAL MIX** to ON.

### Assemble Editing

Allows the required scenes (picture and sound) to be picked up from one or more recorded tapes and recorded in any desired order onto another tape.

#### Playback VTR



#### Recording VTR

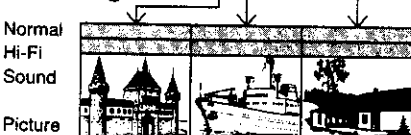

### VITC Editing (option)

Upgrading can be done through your dealer or one of our Panasonic Service Centers.

- VITC enables picture-precise editing.
- The VITC can also be read during pause and slow-motion.
- VITC=Vertical Interval Time Code

After upgrading, the NV-HS1000 is able to read or write VITC depending on the application. This time code (VITC) is recorded together with the picture.

# Flow Chart for On Screen Displays

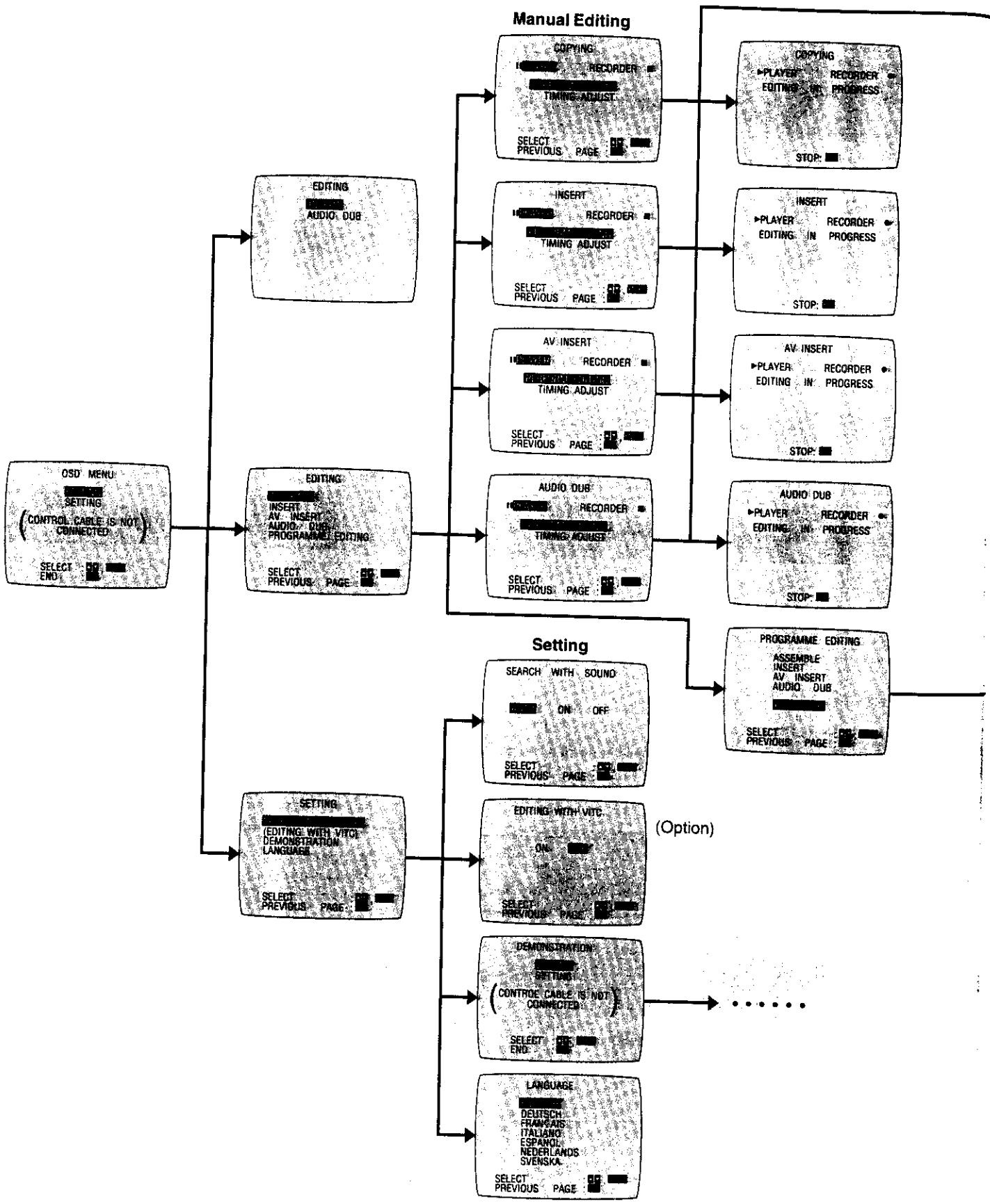

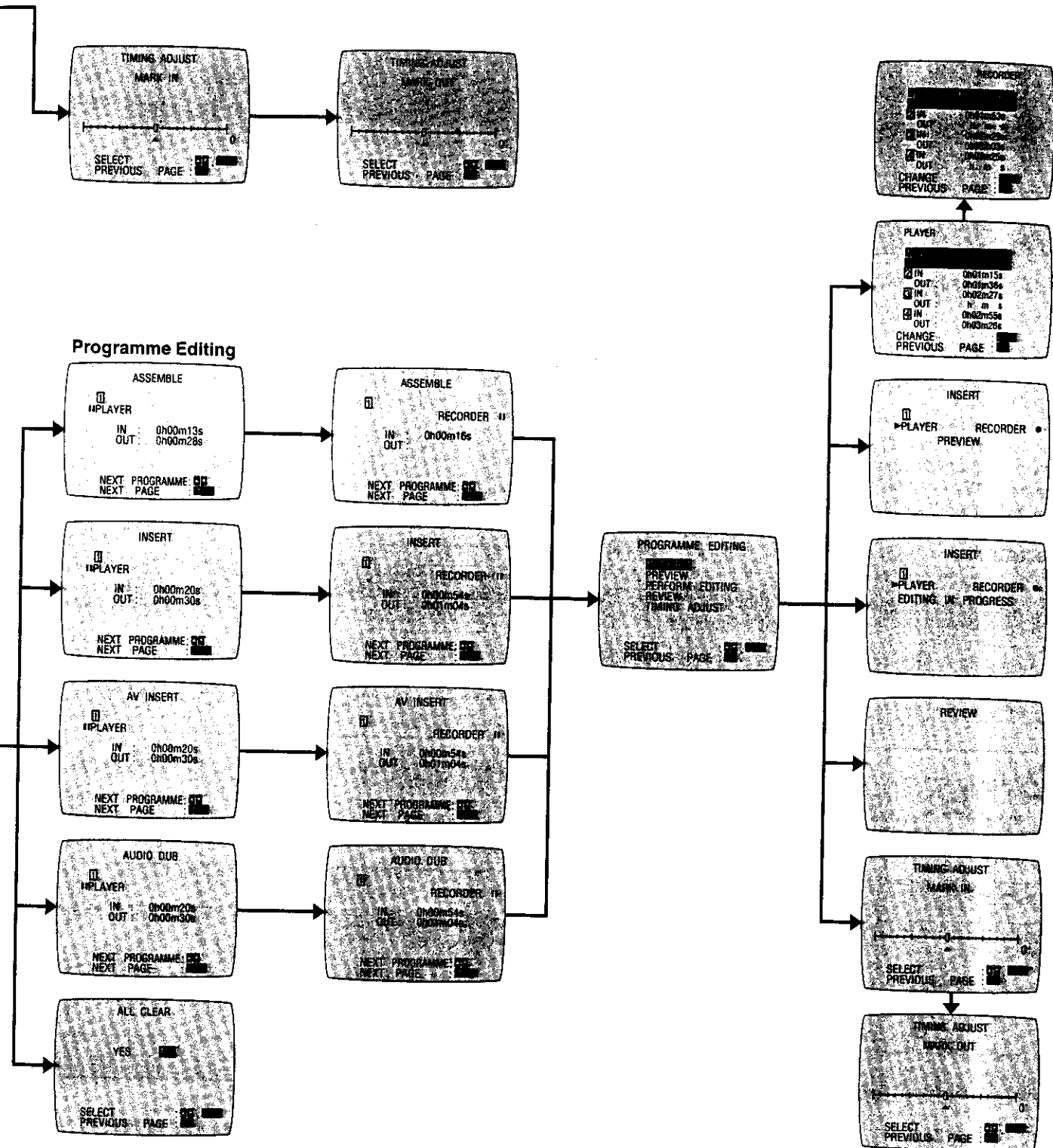

**Caution:**  
 With VITC function, the time code is displayed on the screen in increments of hours, minutes, seconds and frames (25 frames per second).  
 The normal counter also switches to time code display.

# Manual Editing

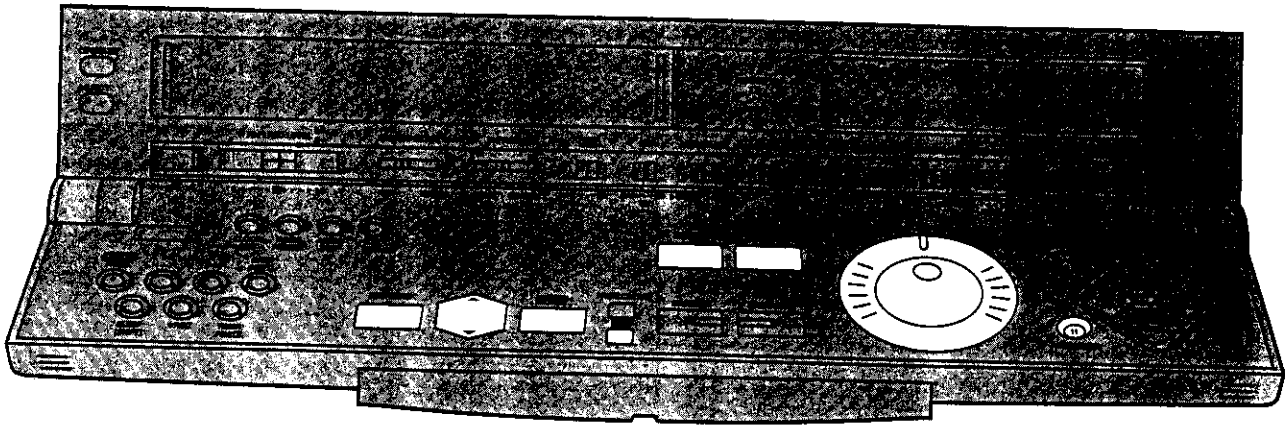

## Copying

### Preparation

- Make the necessary connections. See page 33.
- Insert a recorded cassette into the playback VTR, and a cassette with an intact erasure prevention tab into the recording VTR.
- Confirm that the TV is on.

### Operations

### On Screen Display

1

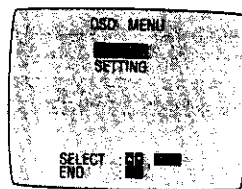

Press **EDIT MENU**.

2

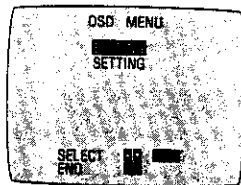
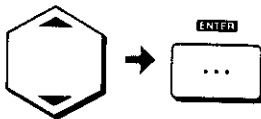

Select **EDITING**.

3

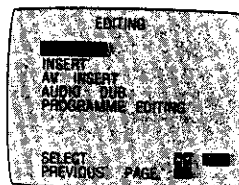
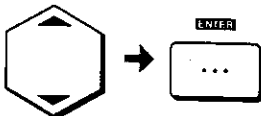

Select **COPYING**.

- If the playback VTR receives no input signals, the On Screen Display may disappear. In such a case, follow the next step and then the On Screen Display will appear.

4

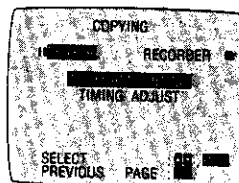

Press **PLAYER** and **PAUSE/STILL**.

- The picture from the playback VTR appears on the screen.

Operations

On Screen Display

5

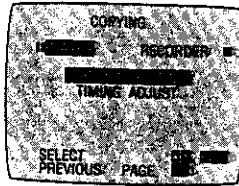
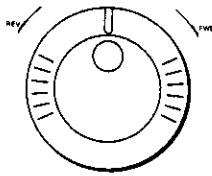

Search for the edit start point on the playback VTR.

6

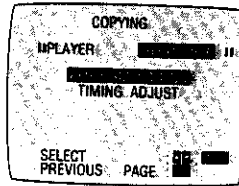
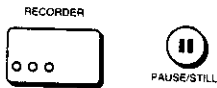

Press **RECORDER** and **PAUSE/STILL**.

- The picture from the recording VTR appears on the screen.
- Steps 6 and 7 need not be performed when a non-recorded cassette is used.

7

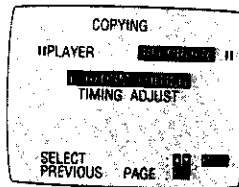
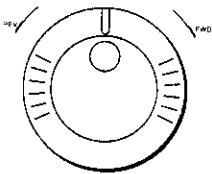

Search for the edit start point on the recording VTR.

8

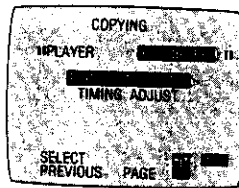

Select **PERFORM EDITING**.

9

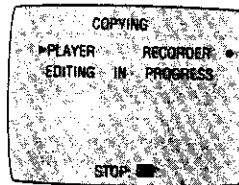

Press **ENTER**.

- Editing begins.

10

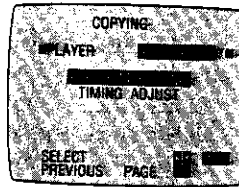

Press **ESC** to stop editing.

11



Press **EDIT MENU**.

- The On Screen Display disappears.

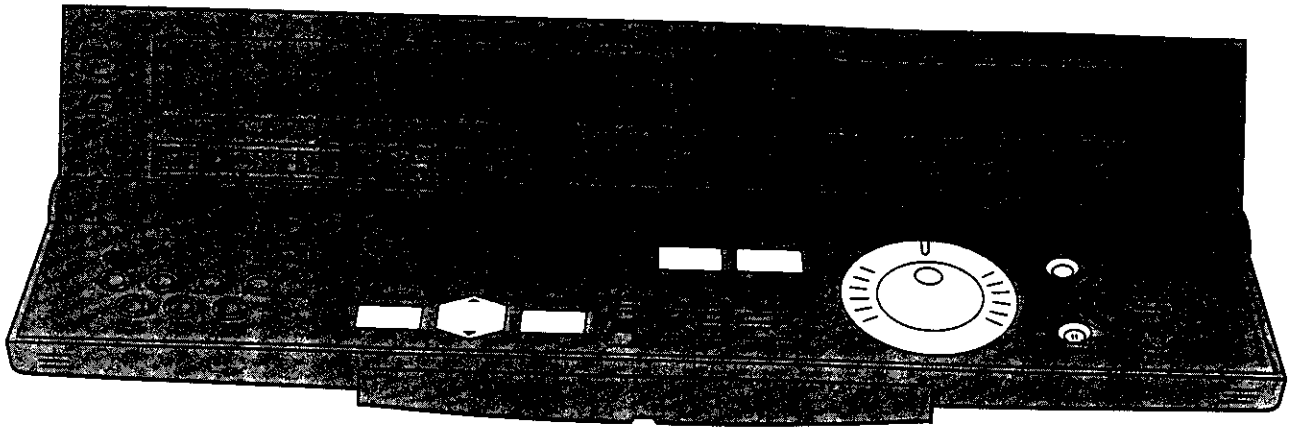

## Insert, AV Insert Editing and Audio Dubbing

**Example:** Insert Editing  
 AV Insert Editing and Audio Dubbing are also performed using the same procedure.

### Preparation

- Make the necessary connections. See page 33.
- Insert a recorded cassette into the playback VTR, and a cassette with an intact erasure prevention tab into the recording VTR.
- Confirm that the TV is on.

### Operations

### On Screen Display

1

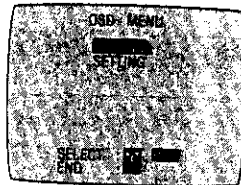

Press **EDIT MENU**.

2

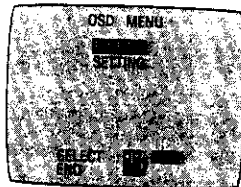
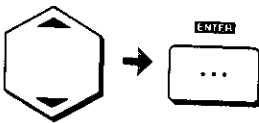

Select **EDITING**.

3

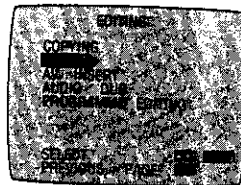
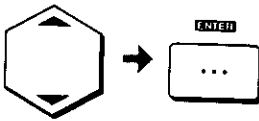

Select **INSERT**.

- If the playback VTR receives no input signals, the On Screen Display may disappear. In such a case, follow the next step and then the On Screen Display will appear.

4

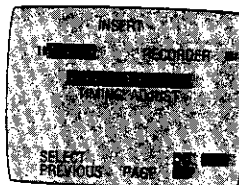

Press **PLAYER** and **PAUSE/STILL**.

- The picture from the playback VTR appears on the screen.



Operations

On Screen Display

5

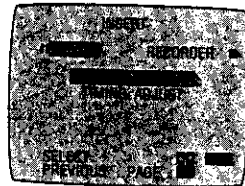
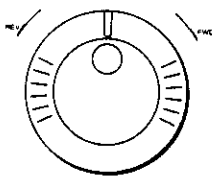

Search for the edit start point on the playback VTR.

6

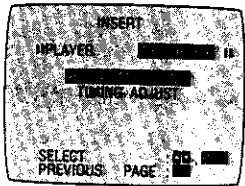
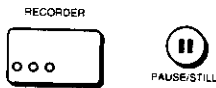

Press **RECORDER** and **PAUSE/STILL**.

- The picture from the recording VTR appears on the screen.

7

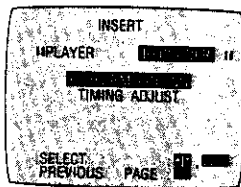
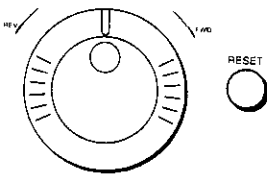

Search for the edit end point on the recording VTR and press **RESET**.

8

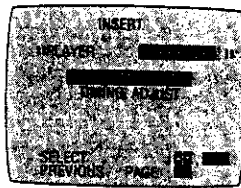
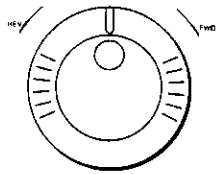

Search for the edit start point on the recording VTR.

9

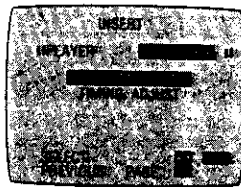

Select **PERFORM EDITING**.

10

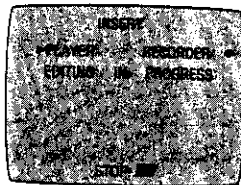
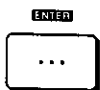

Press **ENTER**.

- Editing begins.
- Editing will finish when the counter reaches 0:00.00.

11



Press **EDIT MENU**.

- The On Screen Display disappears.

**Note:**

If the VITC function is activated, **RESET** is not operative. In such a case, turn off the VITC function.

# Programme Editing

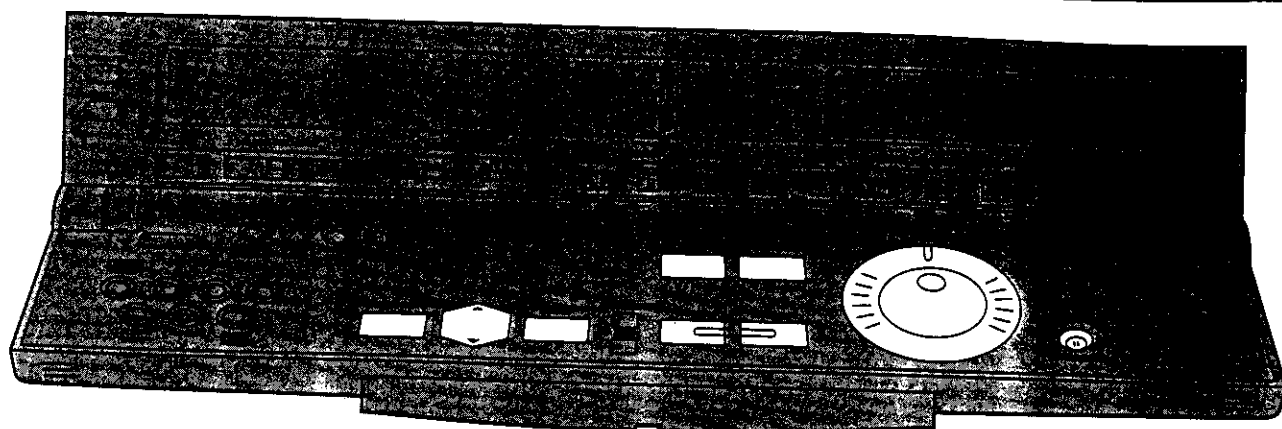

## Assemble Editing



By setting the edit start point and end point on the playback VTR, along with the edit start point on the recording VTR, assemble editing of up to 10 scenes can be performed automatically.

### Preparation

- Make the necessary connections. See page 33.
- Insert a recorded cassette into the playback VTR, and a cassette with an intact erasure prevention tab into the recording VTR.
- Confirm that the TV is on.

### Operations

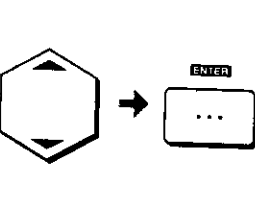
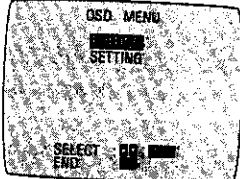
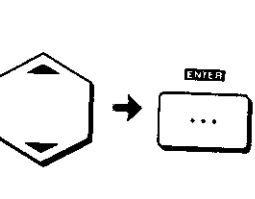
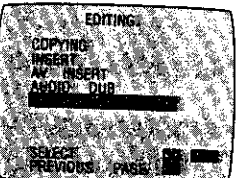
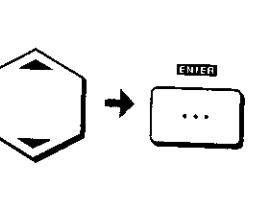
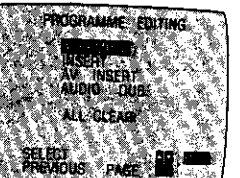
### On Screen Display

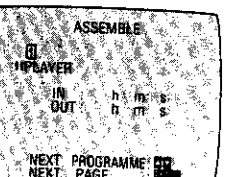
1		Press <b>EDIT MENU</b> .	
2			Select <b>EDITING</b> .
3			Select <b>PROGRAMME EDITING</b> .
4			Select <b>ASSEMBLE</b> . • If the playback VTR receives no input signals, the On Screen Display may disappear. In such a case, follow the next step and then the On Screen Display will appear.
5	 		Press <b>PLAYER</b> and <b>PAUSE/STILL</b> . • The picture from the playback VTR appears on the screen.

Operations

On Screen Display

**6**

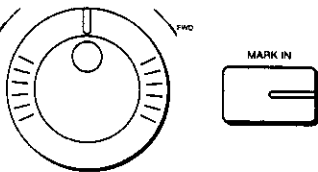
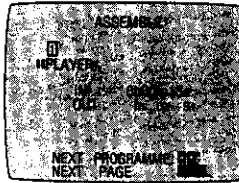
Search for the edit start point on the playback VTR and press **MARK IN**.

**7**

Search for the edit end point on the playback VTR and press **MARK OUT**.

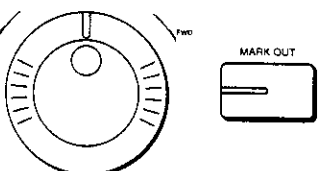
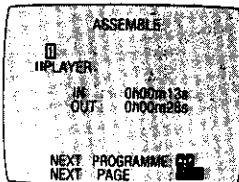
- If there is more than one programme, select a programme number using **▼** and **▲**, and repeat steps 6 and 7.

**8**

Press **RECORDER** and **PAUSE/STILL**.

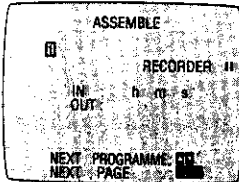
- The picture from the recording VTR appears on the screen.

**9**

Search for the edit start point on the recording VTR and press **MARK IN**.

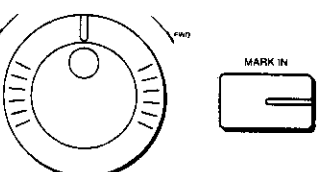
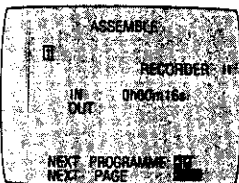
- Step 9 need not be performed when a non-recorded cassette is used.

**10**

Press **ENTER**.

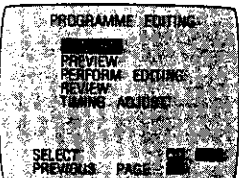
- The edit start point and the edit end point are memorized.

**11**

Select **PERFORM EDITING**.

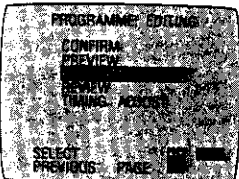
**12**

Press **ENTER**.

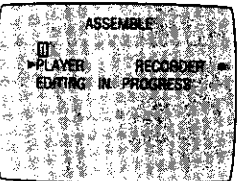
- Editing begins.
- After editing of all programmes is completed, the both VTRs stop in still playback mode.

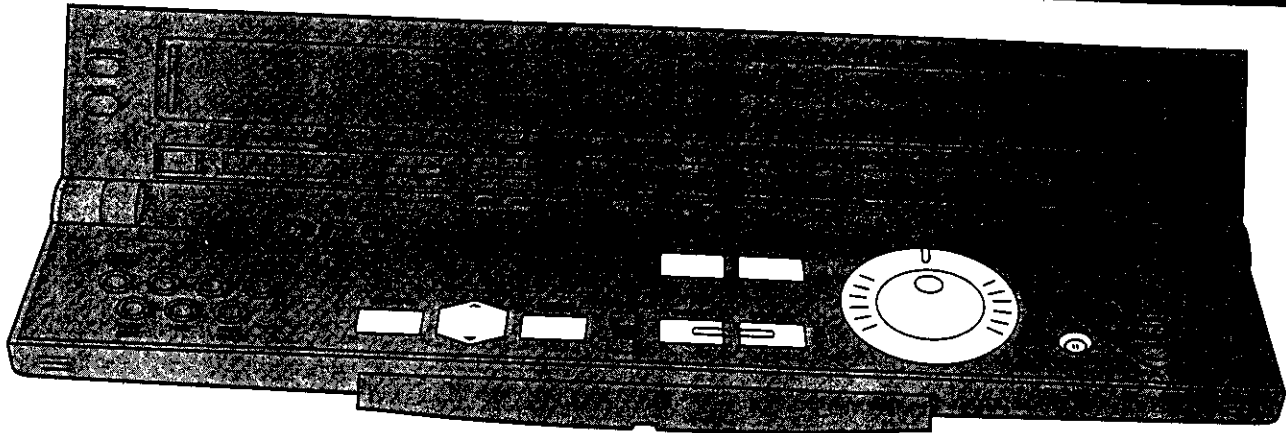

## Insert, AV Insert Editing and Audio Dubbing

There are 2 types of programme.

To insert only a particular portion:

Set the edit start point and end point on the playback VTR, and the edit start point on the recording VTR.

To insert within fixed limits:

Set the edit start point on the playback VTR, and the edit start and end point on the recording VTR.

• If four points are set, insertion will end when the first end point is reached.

### Example: Insert Editing

AV Insert Editing and Audio Dubbing are also performed using the same procedure.

### Preparation

- Make the necessary connections. See page 33.
- Insert a recorded cassette into the playback VTR, and a cassette with an intact erasure prevention tab into the recording VTR.
- Confirm that the TV is on.

### Operations

### On Screen Display



Press **EDIT MENU**.

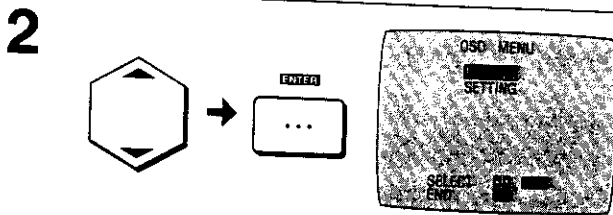

Select **EDITING**.

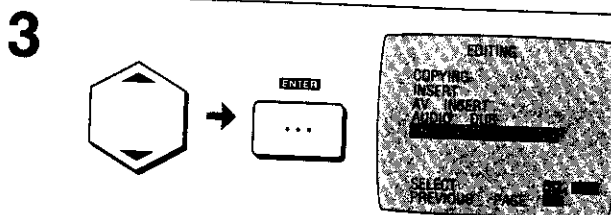

Select **PROGRAMME EDITING**.

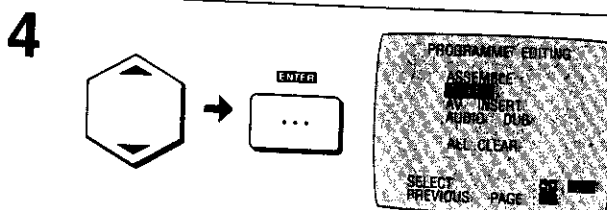

Select **INSERT**.

• If the playback VTR receives no input signals, the On Screen Display may disappear.

In such a case, follow the next step and then the On Screen Display will appear.

Operations

On Screen Display

5

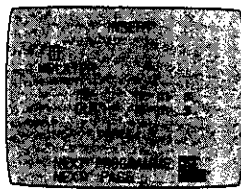

Press **PLAYER** and **PAUSE/STILL**.

- The picture from the playback VTR appears on the screen.

6

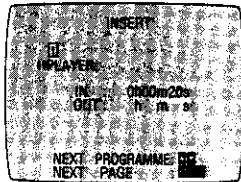
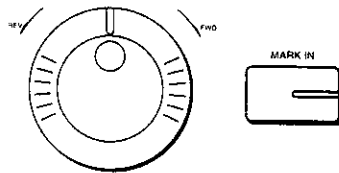

Search for the edit start point on the playback VTR and press **MARK IN**.

7

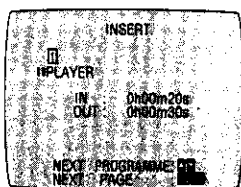
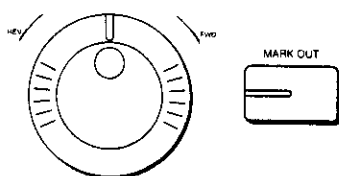

Search for the edit end point on the playback VTR and press **MARK OUT**.

- This step is not necessary if the end point on the recording VTR has been set.

8

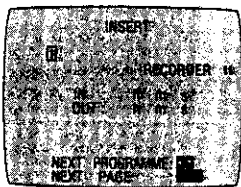

Press **RECORDER** and **PAUSE/STILL**.

- The picture from the recording VTR appears on the screen.

9

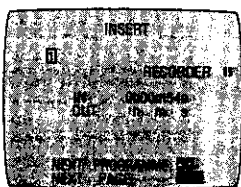
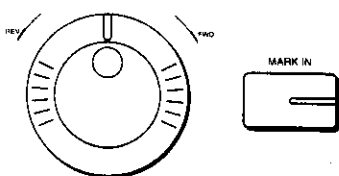

Search for the edit start point on the recording VTR and press **MARK IN**.

10

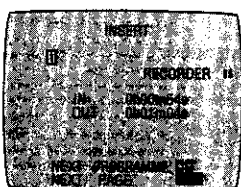
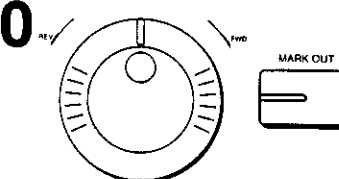

Search for the edit end point on the recording VTR and press **MARK OUT**.

- This step is not necessary if the end point on the playback VTR has been set.
- If there is more than one programme, select a programme number using **▼** and **▲**, and repeat steps 5 to 10.

11

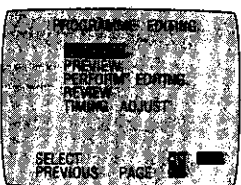

Press **ENTER**.

- The edit start point and the edit end point are memorized.

## Operations

## On Screen Display

# 12

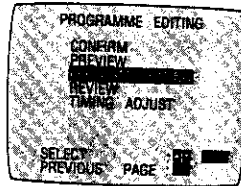

### Select **PERFORM EDITING**.

- If a programme is not correct, it will appear on the screen. Set the edit start and end points correctly.
- To see a preview before performing editing, select **PREVIEW**. See page 48.

# 13

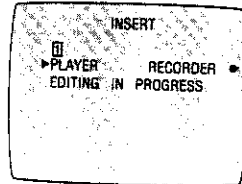

### Press **ENTER**.

- Editing begins.
- After editing of all programmes is completed, the both VTRs stop in still playback mode.

### Notes for Programme Editing:

- For the edit start point, use a location which is at least 10 seconds from the beginning of the tape. Otherwise, the programme will not be executed.
- Programme editing can be suspended in mid-execution by pressing **ESC**. As a result, however, the picture immediately after suspending may disappear.
- Programmes are stored even after editing is completed. Unless they are cancelled, programmes are stored even after the power has been turned off.
- Programme editing can not be performed with a movie camera that has a 4-digit counter.

The following movie cameras will not work in the programme editing mode with this VTR.

VHS full movies: NV-M10E, NV-M25E, NV-M40E, NV-MS4E

VHS-C movies: NV-MS90E

(As of April 1994)

### When the VITC function is on:

- If the programme on the normal counter has been stored, the On Screen Display shown below may appear after step 4. If editing is to be performed using the VITC function, select **YES** to cancel all the editing programmes. (When the VITC function is off, the On Screen Display shown below will appear if the programme with the time code has been stored.)

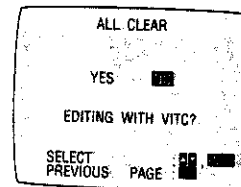

- When **MARK IN** or **MARK OUT** is pressed, the time code is displayed on the screen in increments of hours, minutes, seconds and frames (25 frames per second).

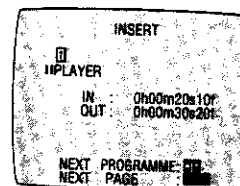

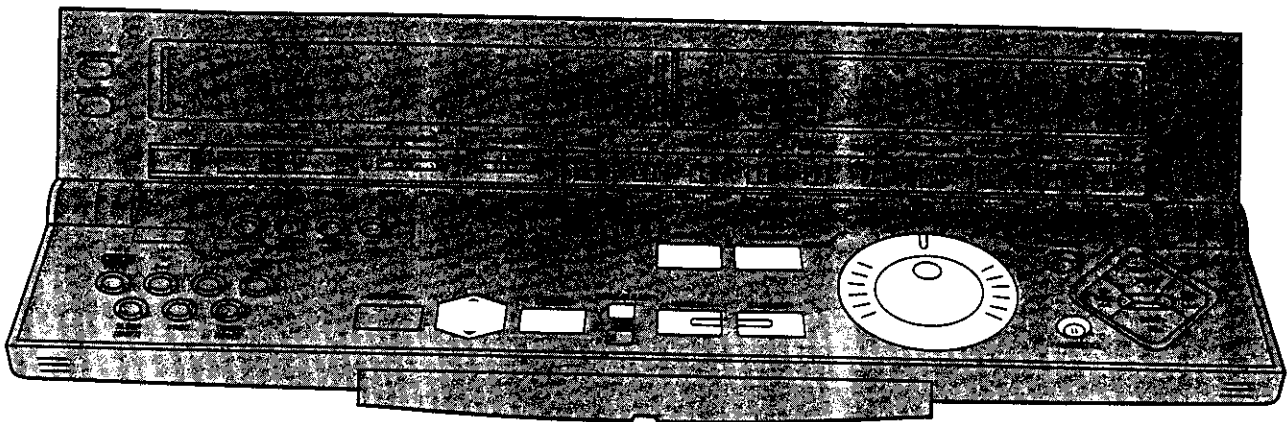

## Other Editing Functions

### To confirm and Change Editing Programmes

- 1 Select **CONFIRM** after setting the edit start and end points.

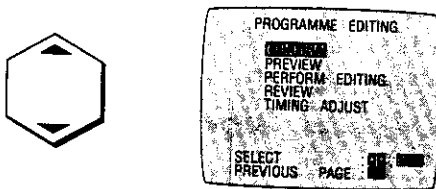

- 4 Select the programme to be changed.

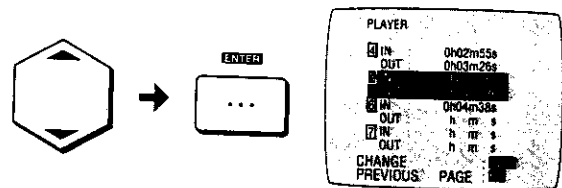

- 2 Press **ENTER**.  
•The programme list for the playback VTR is displayed.

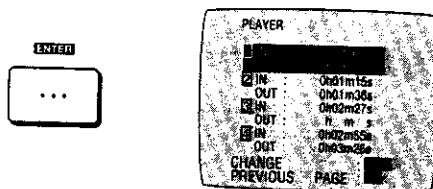

- 5 Search for the start or end point to be changed and press **MARK IN** or **MARK OUT**.

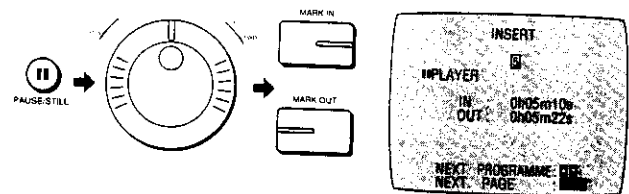

- 3 Press **RECORDER** to confirm the programmes on the recording VTR.  
•Press **PLAYER** to return to the programme list on the playback VTR.



- 6 Press **ENTER**.

### To cancel an Editing Programme

In step 4 above, select the programme to be canceled and press **PROG. CLEAR**.

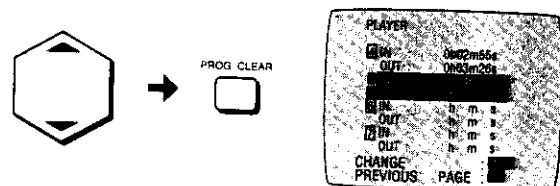

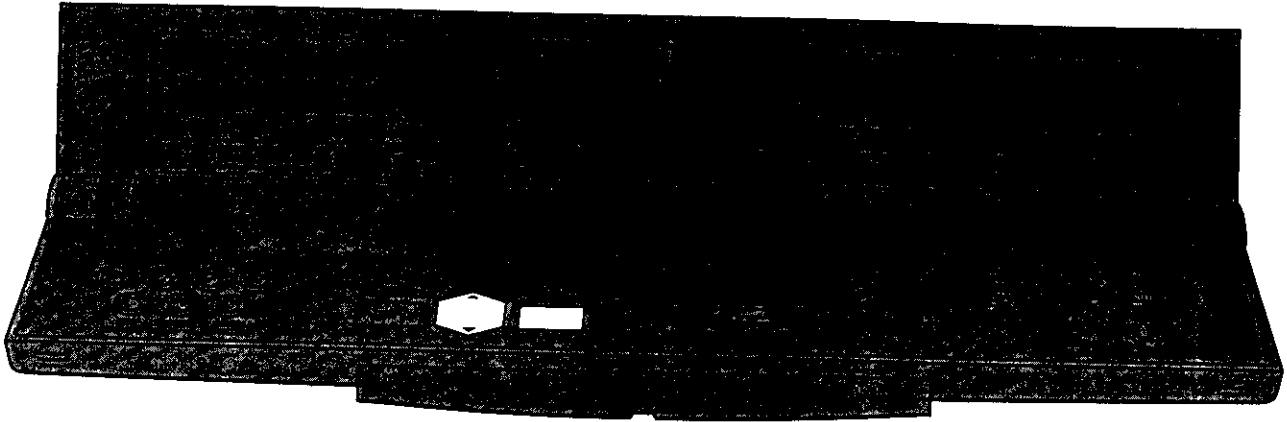

### Preview Function

Before performing actual editing, this function allows confirmation of editing operations without recording.

- 1 Select **PREVIEW** after setting the edit start and end points.

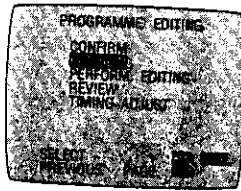

- 2 Press **ENTER**.
  - Preview begins.

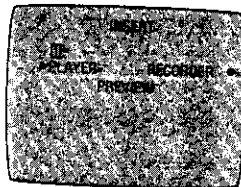

### Notes:

- Preview function works only when this VTR is used as the recording VTR.
- Preview function does not work during assemble editing.

### Review Function

After editing has been completed, this function plays back from the edit start point to the edit end point on the recording VTR.

- 1 Select **REVIEW** after performing editing.

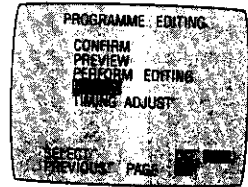
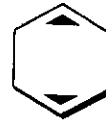

- 2 Press **ENTER**.
  - Review begins.

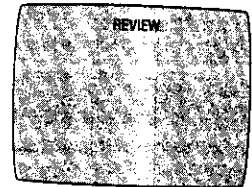



### Edit Timing Adjustment

When performing editing in conjunction with a unit which has a different mechanism, there may be a lag in the edit start point due to a deviation between the time a pause cancellation signal is received by the recording unit and the time recording actually begins.

Edit Timing Adjustment is used to compensate the edit start and end time in light of this start-up time deviation.

- 1 Record the second hand on a stopwatch with a movie camera.
- 2 Insert this recorded cassette into the playback unit, and a cassette with an intact erasure prevention tab into the recording VTR.
- 3 Using the point where the second hand reaches zero as the edit start point, perform copying.
- 4 Play back the copied tape, and check how many seconds had elapsed at the recording start point.
  - If timing is correct, recording should begin at exactly zero seconds.
- 5 Select **TIMING ADJUST** from the screen below.

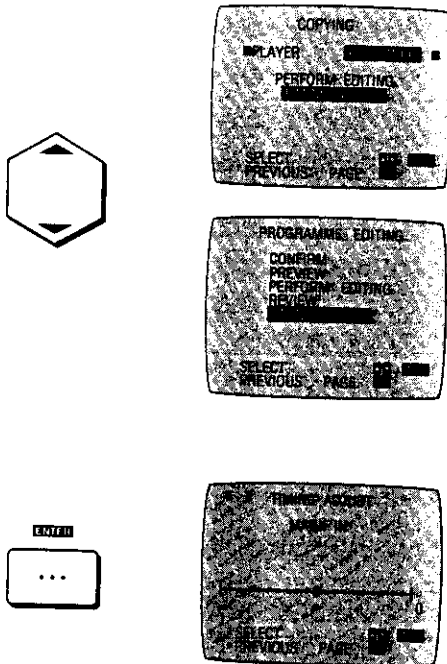

6 Press **ENTER**.

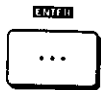

- 7 Adjust the timing for the start point by setting the amount of the discrepancy of the second hand.
  - The setting is displayed in frame ( $\frac{1}{25}$  of a second) units. Thus if, for example, one second had elapsed, set to -25.
  - Corrections can be made in the range of  $\pm 30$  frames (1.2 second).

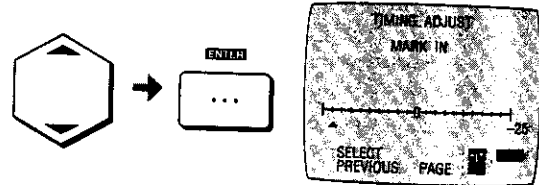

- 8 Adjust the timing for the end point in the same manner.

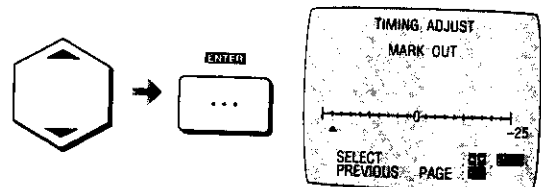

**Note:**  
Edit timing adjustment function only works during programme editing.

### To cancel All Editing Programmes

- 1 Select **ALL CLEAR** from the screen below.

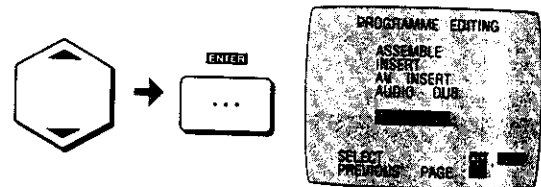

- 2 Select **YES**.
  - All programmes will be canceled.

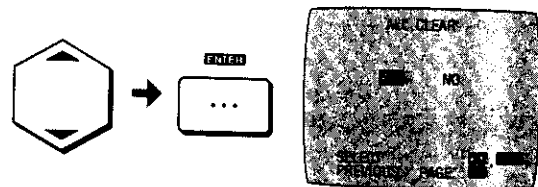

# Editing when not Using an Edit Cable

## To connect a VTR or Movie Camera without an Edit Socket and use This VTR as the Recording VTR

- Connect the AV1 socket on this VTR to the TV.
- Connect the AV2 socket or the AUDIO/VIDEO/S-VIDEO IN (AV3) sockets on this VTR to the playback unit.
- Select A2 or A3 by pressing  $\wedge$   $\vee$  on this VTR.
  - A2: Through the AV2 socket
  - A3: Through the AV3 sockets on front panel
- Set **INPUT SELECT** on this VTR.
  - S-VIDEO: Through the S-VIDEO IN and AUDIO IN sockets
  - LINE: Through the VIDEO IN and AUDIO IN sockets
- Set **EDIT MODE** on this VTR to **RECORDER**.
- Control is performed by the respective units.

## Preparation

- Make the necessary connections.
- Insert a recorded cassette into the playback unit, and a cassette with an intact erasure prevention tab into the recording VTR.
- Confirm that the TV is on.

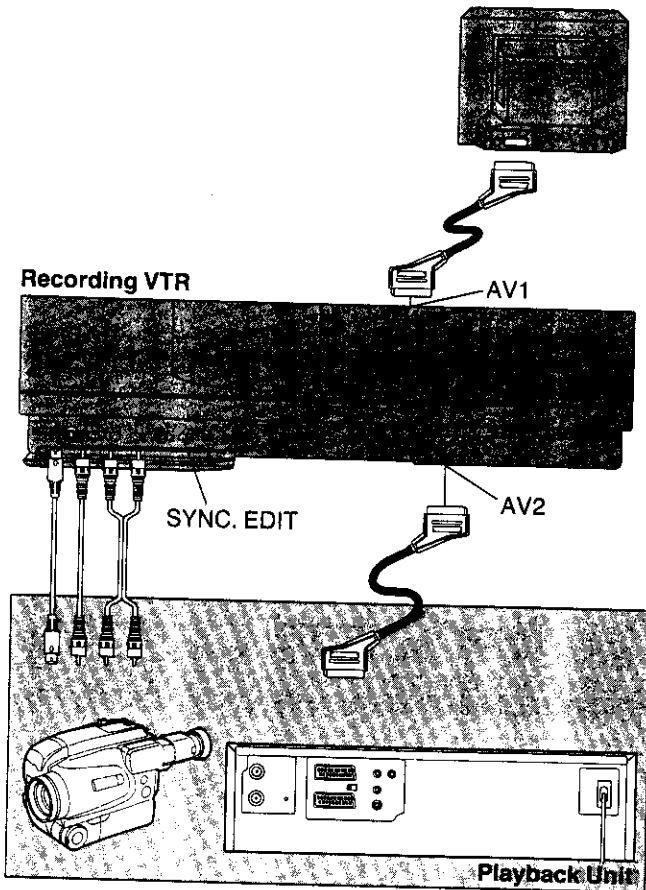

## Assembly Editing

### Operations

- 1 Press **PAUSE/STILL** on the recording VTR.



- 2 Search for the end of the previous recording.

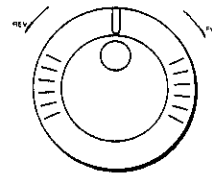

- 3 Press **REC** to set for the new recording.



- 4 Start playback on the playback unit.

- 5 Press **PAUSE/STILL** again to start the new recording.



- 6 Press **STOP** to stop recording.



## Synchronized Editing

By connecting a VTR or movie camera with synchronized editing capability to this VTR using a synchro connection cord (optional), it is possible to synchronize the playback start and stop of the playback unit with the recording start and stop of this VTR.



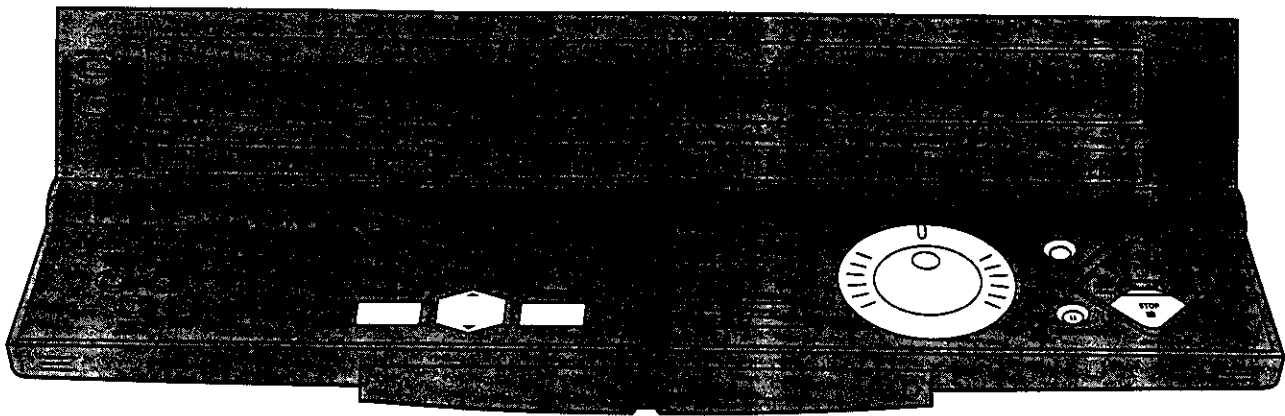





- 1 Put the recording VTR into the recording pause mode by pressing **REC** and **PAUSE/STILL**.
- 2 Put the playback unit into the still playback mode at the point where editing is to begin.
- 3 Press **PAUSE/STILL** on the recording VTR.
  - The playback unit switches over to the playback mode, and copying begins automatically.

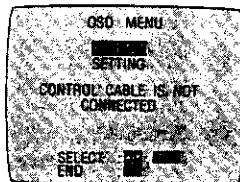
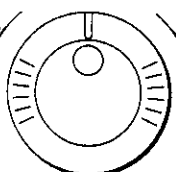

## Insert Editing, AV Insert Editing and Audio Dubbing

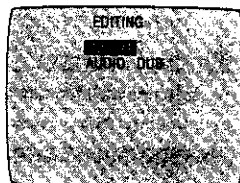
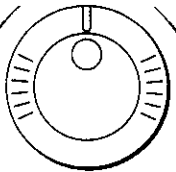
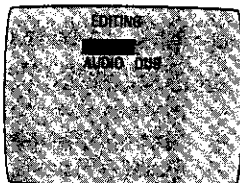
### Operations

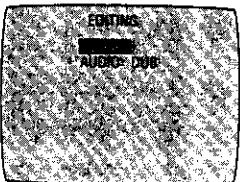
### On Screen Display

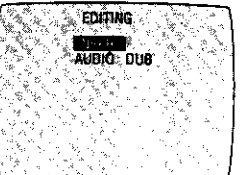
- |   |   |   |  |
|---|---|---|--|
| 1 |    | Press <b>EDIT MENU</b> .  |  |
| 2 |  →    |   | Select <b>EDITING</b> .  |
| 3 |    |  | Press <b>PAUSE/STILL</b> and search for the edit end point, and press <b>RESET</b> .<br>• It is not required for audio dubbing to search for the edit end point and reset.   |
| 4 |    |  | Search for the edit start point.   |
| 5 |  →    |  | Select <b>INSERT</b> or <b>AUDIO DUB</b> .<br>• AV insert editing is selected if both <b>AUDIO DUB</b> and <b>INSERT</b> are selected.<br>• If once selected, Insert or Audio Dubbing mode is still active even if the On Screen Display disappears by pressing <b>EDIT MENU</b> . |
| 6 |   |   | Start playback on the playback unit.   |
| 7 |    |  | Press <b>PAUSE/STILL</b> .<br>• Editing begins.<br>• Insert and AV insert editing will finish when the counter reaches 0:00.00.<br>• Press <b>STOP</b> to stop audio dubbing.  |

# Controls and Connection Sockets

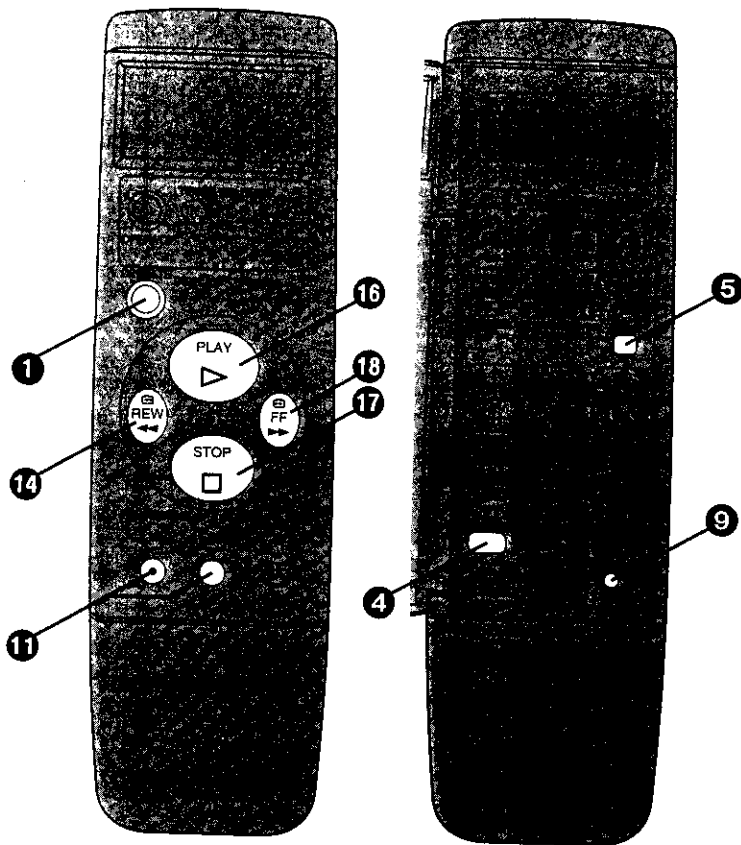
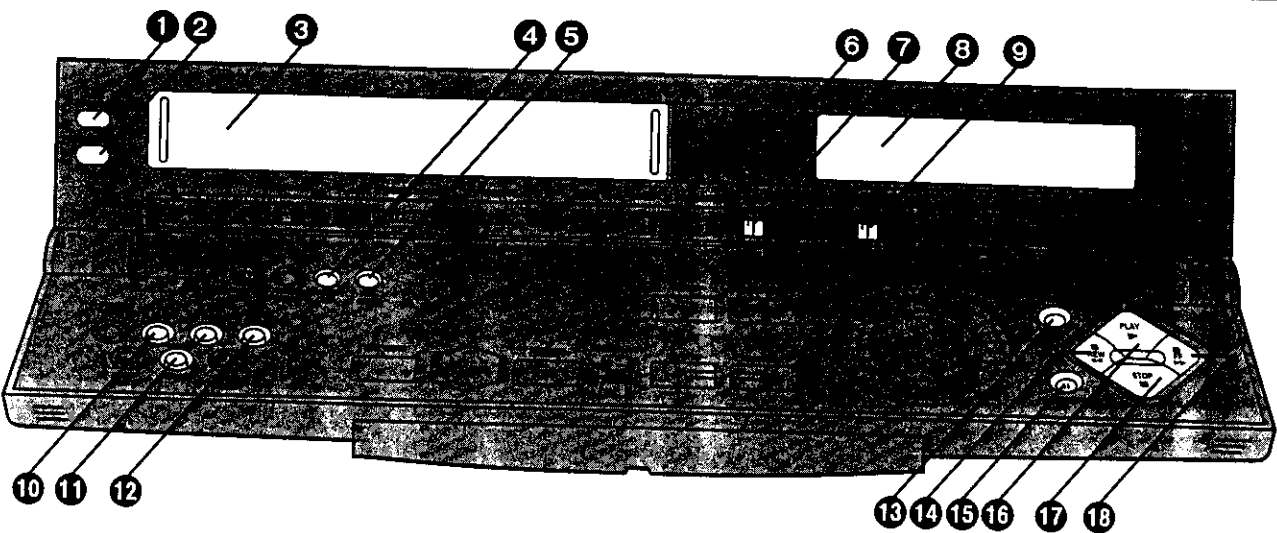

## Basic Controls

- 1 OPERATE**  
To turn the VTR on and off.
- 2 EJECT**  
To eject a video cassette.
- 3 Cassette Compartment**  
Insert a video cassette here.
- 4 AUDIO OUT**  
To select the desired sound mode.  
At the every push of this button, the audio output mode changes as follows.  

→Stereo→Left→Right→Normal audio track→

  
 The Left and Right Indicators show which sound mode is selected in the following way.  
 Stereo: Both the Left and Right Indicators are lit.  
 Left: The Left Indicator is lit.  
 Right: The Right Indicator is lit.  
 Normal: Both the Left and Right Indicators are not lit.
- 5 AV LINK**  
To select the VTR mode or TV mode for AV LINK.
- 6 S-VHS Indicator**  
Lights up when the S-VHS switch is set to ON.

**7 S-VHS**

When recording on an S-VHS cassette tape, select the desired recording format with this switch.

ON: The recording will be made in the S-VHS format.

- The S-VHS indicator lights up.

OFF: The recording will be made in the VHS format.

- The S-VHS indicator does not light up.

(It is possible to make a recording on an S-VHS cassette tape in the VHS format, for example, in order to play back the tape on another VHS VTR.)

- When using VHS cassettes, the recording is made in the VHS format irrespective of the position to which this switch is set.

- For playback, it is not necessary to operate this switch.

- When a tape which was recorded in the S-VHS format is played back on a conventional VHS VTR, it is not possible to obtain playback picture.

**8 Display**

**9 REMOTE MODE (VTR1/2/3)**

VTR1: Set to this position on both the VTR and remote controller for normal use with one VTR.

VTR2: Set to this position when using two Panasonic VTRs.

VTR3: Set to this position when using three Panasonic VTRs.

This allows the remote controller to be set for operating VTR1, VTR2 or VTR3.

**10 ∇ (-) ^ (+)**

To select the required programme position (TV station).

To set the clock and timer recording.

**11 REC**

To start a recording.

**12 SP/LP (NEXT)**

To select the tape speed required for recording.

SP gives the best picture quality.

LP gives the longest recording time.

To proceed to the next item during setting procedure.

**13 RESET**

To reset the tape counter (elapsed time) to "0:00.00".

- The tape counter is automatically reset to "0:00.00" when a video cassette is inserted.

**14 REW (REWIND)**

In the stop mode: To rewind the tape.

In the playback mode: To search backward.

In the rewind mode: To obtain high speed picture. " $\ll$ " is lit.

**15 PAUSE/STILL**

In the stop mode: Still picture (Jog/Shuttle mode)

During playback: Still picture (Jog/Shuttle mode)

During recording: To interrupt recording

**16 PLAY**

To start playback. " $\triangleright$ " is lit.

**17 STOP**

To stop any playback or recording.

**18 FF (FAST FORWARD)**

In the stop mode: To fast forward the tape.

In the playback mode: To search forward.

In the fast forward mode: To obtain high speed picture. " $\triangleright\triangleright$ " is lit.

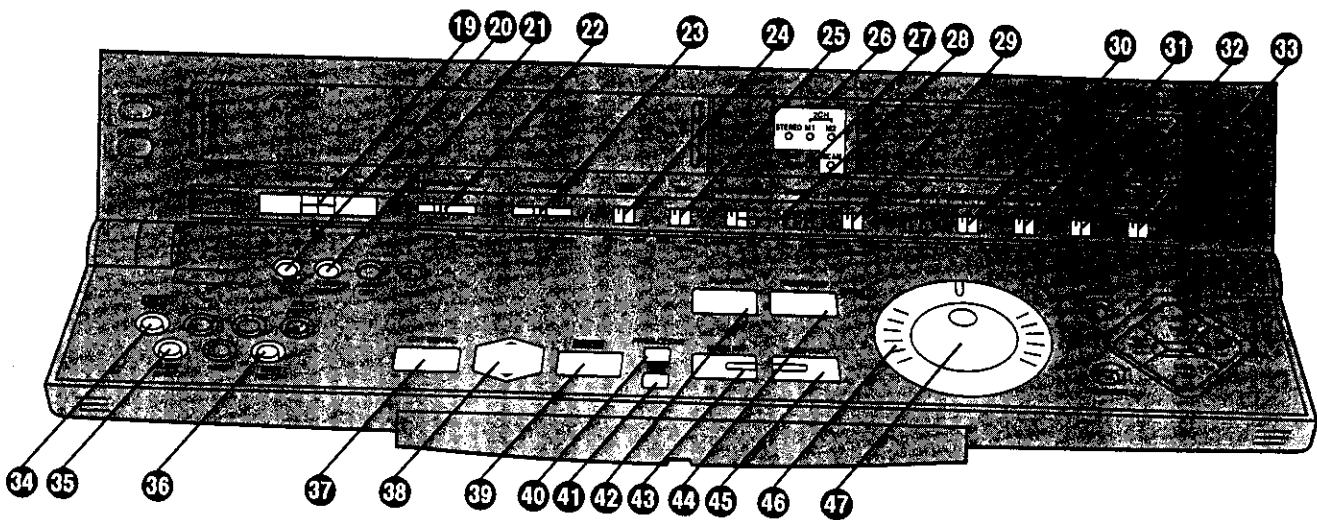

## Advanced Controls

- 19 Hi-Fi REC LEVEL**  
To adjust the recording level to peak at +4 dB on the recording level indicator.
- 20 CLOCK SET**  
To set the time.
- 21 TUNER PRESET**  
To initiate TV station settings for the tuner.
- 22 PHONES LEVEL**  
For adjusting the volume level of connected stereo headphones.
- 23 PICTURE**  
To make picture sharper (SHARP) or softer (SOFT).
- 24 TBC**  
When the tape in the cassette is loose or damaged, or when the tape movement is unstable during recording or playback, the playback picture may shake from side to side and the picture may become distorted. In this case, activate the Time Base Corrector by setting the TBC Switch to ON, and the picture will become stable and the shaking will be minimized.
  - For normal use, set the TBC Switch to OFF.
  - During playback of some pre-recorded tapes, the tape may shake vertically. In such a case, set the TBC Switch to OFF.
  - This function only works during normal playback in the PAL system.
- 25 16:9**  
  - AUTO:** For automatically identifying the pictures as 16:9 pictures or 4:3 pictures during recording and playback and showing them on the wide TV screen.
    - Normally set at this position.
  - ON:** For recording and playback in such a way that the pictures expanded to 16:9 are shown on the wide TV screen at all time.
  - OFF:** For recording and playback in such a way that 4:3 pictures are shown on the wide or 4:3 TV screen at all times.

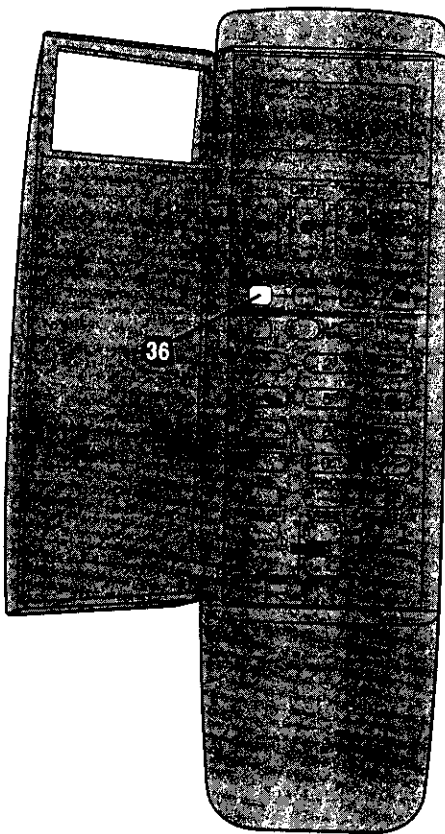

**26 Indicators for Stereo, Bilingual and NICAM Reception**

When receiving a TV programme, the type of sound system in which it is broadcast is automatically indicated.

**27 AI Indicator**

Lights up when the AI function is on.

**28 INPUT SELECT**

When Recording via the AV3 sockets on the front panel, select A3 by pressing  $\wedge \vee$  and set this switch to S-VIDEO or LINE.

S-VIDEO: Through the S-VIDEO IN and AUDIO IN sockets

LINE: Through the VIDEO IN and AUDIO IN sockets

**29 EDIT MODE**

PLAYER: When this VTR is used as the playback VTR during editing operations.

RECORDER: When this VTR is used as the recording VTR during editing operations.  
 •Normally set at this position.

PASSIVE: When operating this VTR using another VTR or an editing controller.

•The picture quality best suited for editing is selected.

•When setting at this position, operation will not be possible and the On Screen Display will not appear.

**30 Hi-Fi/NORMAL MIX**

OFF: Normally set at this position to reproduce the better sound available from the Hi-Fi track.

ON: Both sound tracks (the Hi-Fi sound track and the normal sound track) are played back mixed together. Use this setting when playing back a cassette tape which has been insert edited or audio dubbed.

**31 VIDEO MODE**

COLOUR: When performing recording and playback in colour.

AUTO: The VTR automatically distinguishes between colour and black-and-white during recording and playback.

B/W: When performing recording and playback in black-and-white.

**32 AI**

ON: Using the AI function, recording and playback are performed in the state which achieves optimum picture quality in light of characteristics of a tape.  
 •The picture sharpness cannot be adjusted in this setting.

OFF: Turns off the AI function.

**33 MONO**

OFF: Normally set at this position.

ON: Only set at this position to record the normal sound during a stereo, bilingual or NICAM broadcast or if the stereo sound is distorted due to inferior reception conditions.

**34 CHECK/PROG**

To select a timer programme number.

"1, 2, 3... or 8" is lit.

To display details of preset timer recording.

**35 SLEEP (SHIFT)**

To set the time to turn off the VTR automatically.

To blank unoccupied programme position.

**36 TIMER REC**

To turn the timer recording function on and off.

$\square$  is lit or not lit.

Once Operating timer recording function, the normal VTR operation is not possible unless this button is set to off.

**37 EDIT MENU**

To perform editing operations.

**38  $\blacktriangle \blacktriangledown$**

To make selections from On Screen Display.

**39 ENTER**

To make selections from On Screen Display.

**40 PROG. CLEAR**

To cancel an editing programme.

**41 ESC**

To return to the previous page on the screen.

To stop editing.

**42 PLAYER**

To operate the playback VTR.

**43 MARK IN**

To set the edit start point.

**44 RECORDER**

To operate the recording VTR.

**45 MARK OUT**

To set the edit end point.

**46 Shuttle Ring**

To adjust playback speed backward or forward.

**47 Jog Dial**

To locate any desired frame with utmost precision.

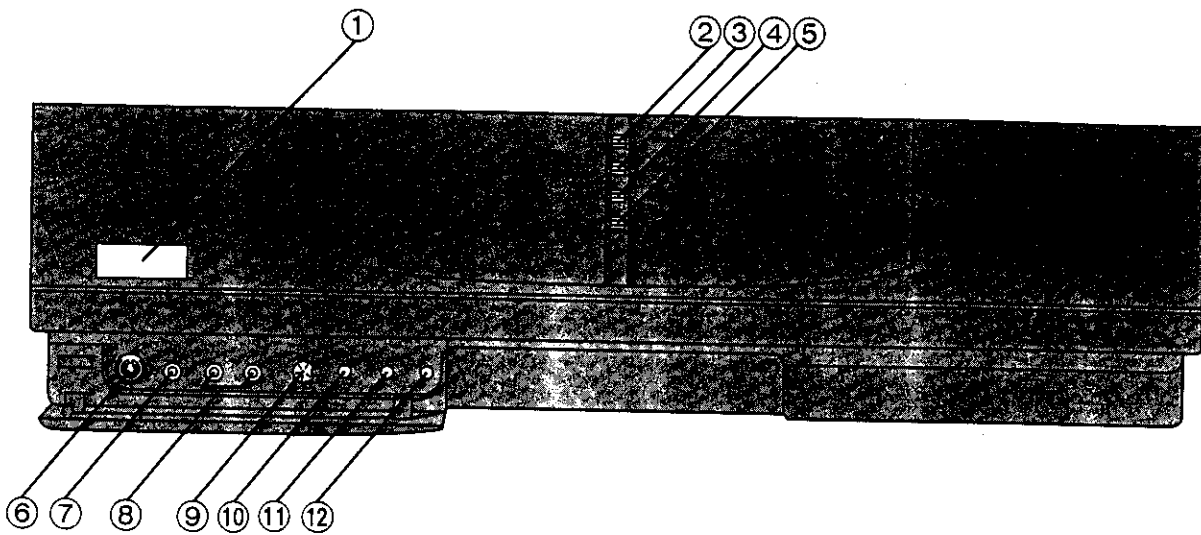

- ① **Infrared Remote Control Receiver Window**
- ② **OPERATE Indicator**  
Lights up when the VTR is turned on.
- ③ **STAND BY Indicator**  
Lights up when the AC mains lead is connected and the VTR is turned off.
- ④ **TIMER REC Indicator**  
Lights up when the timer recording function is on.
- ⑤ **TAPE IN Indicator**  
Lights up when a cassette is inserted.
- ⑥ **S-VIDEO IN (AV3)**  
To connect the S-Video cable to a movie camera or to another VTR that has a S-Video output socket.
- ⑦ **VIDEO IN (AV3)**  
To connect the video cable to a movie camera or to another VTR.
- ⑧ **AUDIO IN (AV3)**  
To connect the audio cable to a movie camera or to another VTR.
- ⑨ **EDIT**  
To connect a movie camera or another VTR equipped with an edit socket or an editing controller.
- ⑩ **SYNC. EDIT**  
To connect a movie camera or another VTR equipped with synchronized editing capability.
- ⑪ **MIC**  
To connect a microphone for recording. Once connected, this socket has priority.
- ⑫ **PHONES**  
To connect stereo headphones.



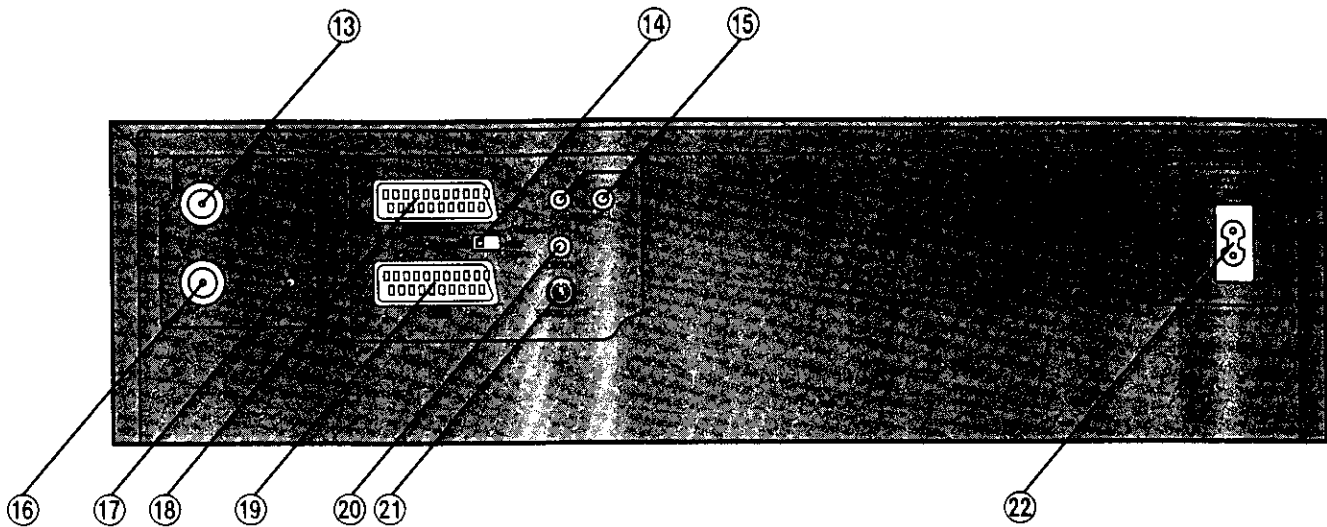

- 13 RF OUT**  
To connect to the aerial terminal on a TV set.
- 14 NORMAL/S-VIDEO OUT/TEST SIGNAL**  
**NORMAL:** Normally set to this position.  
**S-VIDEO OUT (AV1):**  
 Set to this position when connecting the VTR to a TV set equipped with 21-pin Euro-AV Connector with pins for separate Y/C signal input.  
**TEST SIGNAL:**  
 Set to this position when tuning the TV into the VTR.  
 The test signal is transmitted on channel 36 and AV1.
- 15 AUDIO OUT**  
To connect the sound to a stereo audio system.
- 16 RF IN**  
To connect to the external aerial.
- 17 CH ADJ.**  
To adjust the RF transmitting channel 32~40.
- 18 AV1**  
This 21-pin scart terminal carries input and output signals for both picture and sound. TV sets equipped with a similar socket can be connected here. This is also called Scart

Peritel  
Euro Connector  
Euro AV

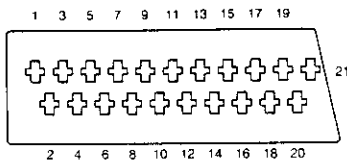

NORMAL (AV1/AV2)	S-VIDEO (AV1)
1 AUDIO OUTPUT CH2 (R)	1 AUDIO OUTPUT CH2 (R)
2 AUDIO INPUT CH2 (R)	2 AUDIO INPUT CH2 (R)
3 AUDIO OUTPUT CH1 (L)	3 AUDIO OUTPUT CH1 (L)
4 AUDIO GND	4 AUDIO GND
5 BLUE GND	5 No connection
6 AUDIO INPUT CH1 (L)	6 AUDIO INPUT CH1 (L)
7 BLUE	7 No connection
8 SWITCHING VOLTAGE	8 SWITCHING VOLTAGE
9 GREEN GND	9 No connection
10 No connection	10 No connection
11 GREEN	11 No connection
12 No connection	12 No connection
13 RED GND	13 No connection
14 BLANKING GND	14 No connection
15 RED	15 C OUT
16 BLANKING	16 No connection
17 VIDEO OUTPUT GND	17 VIDEO OUTPUT GND
18 VIDEO INPUT GND	18 No connection
19 VIDEO OUTPUT	19 Y OUT
20 VIDEO INPUT	20 VIDEO INPUT
21 GND	21 GND



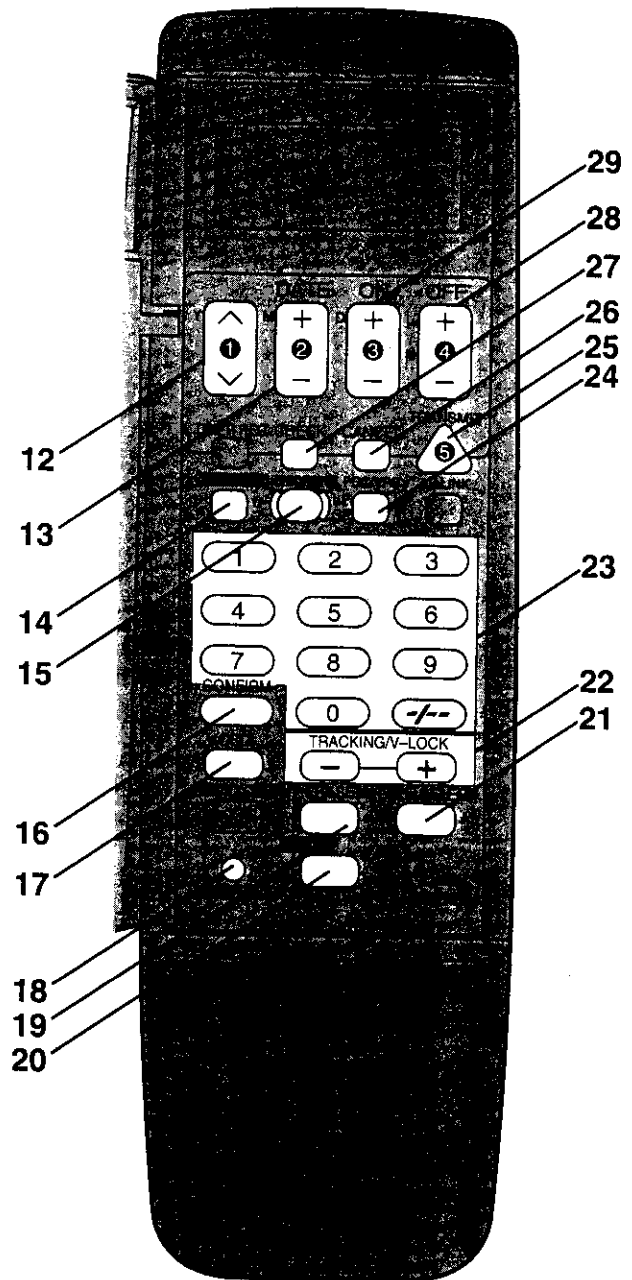
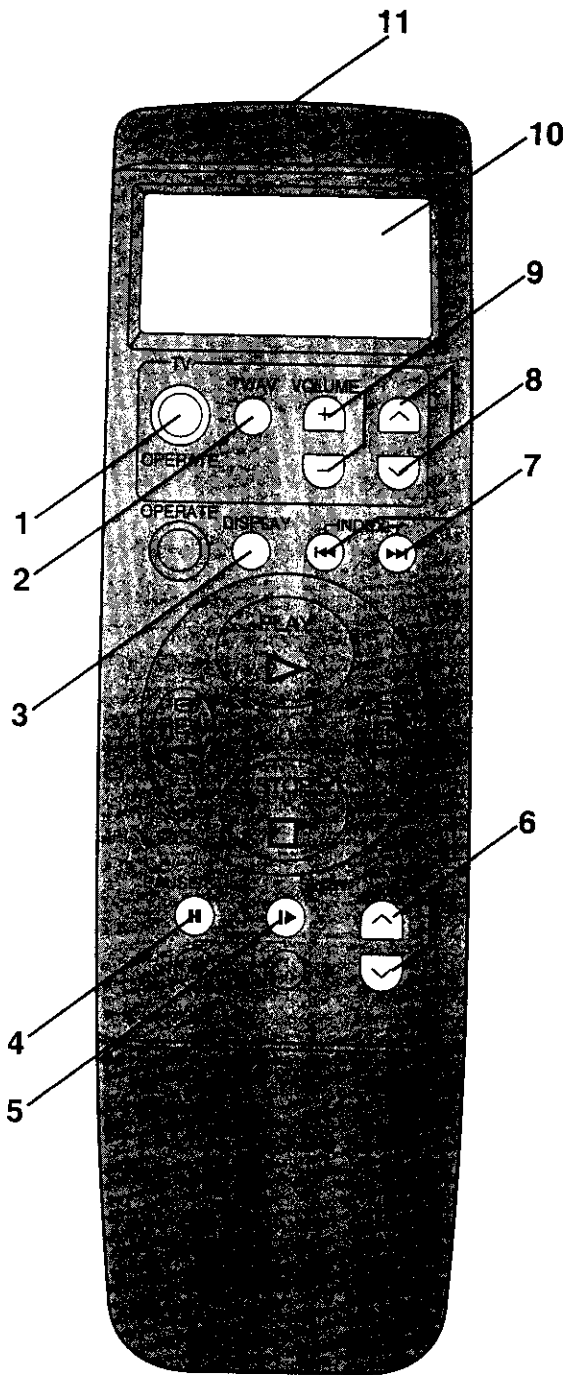

Caution: RGB reservation for only E/E operation when connecting the Pay TV decoder

- 19 AV2**  
To connect to a decoder or another VTR.  
●Only used as the input socket.
- 20 VIDEO OUT**  
To connect the video cable to a TV or another VTR.
- 21 S-VIDEO OUT**  
To connect the S-Video cable to a TV or another VTR that has a S-Video input socket.
- 22 AC IN~**  
To connect to the main power supply.

# Infra-red Remote Controller



- 1 OPERATE (TV)**  
To turn the TV on and off.  
●With some TV models, it may only be possible to turn the TV off using this button.
- 2 TV/AV**  
To select the TV input.
- 3 DISPLAY**  
To change the indication on the VTR Display.  
→Clock→Counter→Remaining Tape Time→
- 4 PAUSE/STILL**  
During playback: Still picture  
During recording: To interrupt recording
- 5 SLOW**  
To activate slow playback.
- 6 ∇∧ (VTR)**  
To select the required programme position (TV station) of the VTR.
- 7 INDEX**  
For the index search function.
- 8 ∇∧ (TV)**  
To select the required programme position (TV station) of the TV.
- 9 VOLUME**  
To adjust the volume of the TV.
- 10 Display**
- 11 Infra-red Transmitter**  
The programming data are transmitted from here to the VTR.
- 12 ∧∇ (Y)**  
●To programme a timer recording.  
●To set the clock.  
●To preset the TV stations.
- 13 DATE (M)**  
●To programme a timer recording.  
●To set the clock.
- 14 SHOWVIEW**  
For the ShowView programming.
- 15 RECORDING SP/LP**  
To select the tape speed desired for recording.
- 16 CONFIRM**  
To convert the data of a ShowView number.
- 17 OSD**  
For the On Screen Display Function.
- 18 CLOCK/PRESET**  
●To set the clock.  
●To preset the TV stations.  
●To set the manufacturer number of the TV.

- 19 ERASE**  
To erase Index Signals.
- 20 WRITE**  
To write Index Signals.
- 21 TAPE SELECT**  
To set the cassette tape length in order to obtain correct indication of the remaining tape time.  
E195: For E30, -60, -90, -120, -180 and -195 tapes  
E240: For E240 tape  
E260: For E260 and -300 tapes
- 22 TRACKING/V-LOCK**  
For manual tracking adjustment  
The + and - buttons are used to adjust the tracking when, for example, noise bars on the picture are better removed manually than by the automatic digital tracking control. After making a manual adjustment, press both buttons together to return to automatic digital tracking control.  
  
For slow tracking adjustment  
When noise bars appear during Still, Still Advance or Slow playback, switch over to slow playback and adjust with the + or - Button to reduce the noise bars.  
  
For vertical locking adjustment  
Use the + and - buttons to minimize any vertical jitter during still-picture playback.
- 23 Number Buttons**  
●To select the programme positions.  
  
9:   
  
19:  →  →   
  
●To enter a ShowView number.
- 24 PDC/VPS**  
To turn the PDC/VPS function on and off.
- 25 TRANSMIT**  
To transmit the data that has been set on the remote controller to the VTR.
- 26 CANCEL**  
To cancel timer programmes.
- 27 CHECK**  
To check timer programmes.
- 28 OFF (H/M)**  
●To programme a timer recording.  
●To set the clock.  
●To preset the TV stations.  
●To set the manufacturer number of the TV.
- 29 ON (D)**  
●To programme a timer recording.  
●To set the clock.

# Before Requesting Service

Before requesting service, check the following points once again.

VTR will not operate correctly			
SYMPTOM	CAUSE	REMEDY	CHECKED
VTR display is not illuminated.	Mains lead is not connected.	Reconnect mains lead to VTR.	
VTR display is illuminated but VTR will not operate.	VTR is in timer mode.	Press TIMER REC to operate VTR manually.	
	Safety devices are operating.	Disconnect mains lead and wait for 1 minute. Reconnect mains supply and check functions.	
	Condensation may have formed.	Do not operate VTR for 1 hour.	

Playback will not operate correctly			
SYMPTOM	CAUSE	REMEDY	CHECKED
Picture noisy or not in colour. Horizontal bars or lines run down the screen.	Tracking is not correct.	Adjust the tracking. See page 59.	
	TV set is not tuned to VTR.	Operate NORMAL/S-VIDEO OUT/TEST SIGNAL on VTR and check TV tuning. See page 8.	
	Video heads are clogged or worn.	Consult your dealer for further advice.	
	Colour TV system is not set correctly.	Set correct colour TV system.	

Recording will not operate correctly			
SYMPTOM	CAUSE	REMEDY	CHECKED
"err" indication flashes whenever recording is attempted.	Erase prevention tab on cassette is broken off.	Use tape with intact erasure prevention tab, or cover tab hole with adhesive tape, if original recording is no longer required.	
Picture is recorded with noise or blank screen.	Aerial or aerial lead is defective.	Check aerial connection to VTR. See page 5. Check your normal TV picture. If there is no picture, check your aerial.	
	VTR is not correctly tuned.	Re-tune VTR. See page 12.	
	A1, A2 or A3 is selected.	Select the required TV programme.	
Timer recording cannot be performed.	Clock or calendar is incorrectly set.	Check clock and calendar. Set to present time. (Note this is a 24 hour clock.) See page 9.	
	Recording start or end time settings are incorrect.	Set recording start and end time correctly.	
	VTR is not set for timer recording.	Press TIMER REC after programming for timer recording.	
AV external recordings cannot be made.	A1, A2 or A3 is not selected.	Select A1, A2 or A3 by pressing $\wedge \vee$ .	
	External AV connections are incorrect.	Check that connections for external video and audio source are correct. See page 33.	

Remote controller will not work correctly			
SYMPTOM	CAUSE	REMEDY	CHECKED
Remote controller does not operate correctly.	Remote controller transmitter beam is not reaching VTR.	Ensure that remote controller is being pointed at VTR and that transmitter beam is not obstructed.	
	Distance is too far.	Use remote controller within 7 m of VTR. If this range is not possible, replace batteries.	
	Batteries are exhausted.	Replace batteries. Note precaution for replacement on page 17.	
	Batteries are incorrectly fitted with (+/-) reversed.	Fit batteries correctly as shown on page 17.	

# Specifications

NV-HS1000EC

<b>Power Source:</b>	220-240 V AC, 50-60 Hz
<b>Power Consumption:</b>	41 watts

<b>Video Recording System:</b>	2 rotary heads, helical scanning system	
<b>Video Heads:</b>	4 heads	
<b>Tape Speed:</b>	SP; 23.39 mm/sec. LP; 11.7 mm/sec.	
<b>Tape Format:</b>	VHS/S-VHS tape	
<b>Record/Playback Time:</b>	SP; 240 min. with NV-E240	SP; 260 min. with NV-SE260
	LP; 480 min. with NV-E240	LP; 520 min. with NV-SE260

## VIDEO

<b>Television System:</b>	CCIR; 625 lines, 50 fields, PAL colour signal		
<b>Modulation System:</b>	Luminance; FM azimuth recording		
	Colour signal; converted subcarrier phase shift recording		
<b>Input Level:</b>	AV1/AV2;	1.0 Vp-p,	75 ohm, terminated
	VIDEO IN (AV3) (PHONO);	1.0 Vp-p,	75 ohm, terminated
	S-VIDEO IN (AV3);	1.0 Vp-p,	75 ohm, terminated
<b>Output Level:</b>	AV1/AV2;	1.0 Vp-p,	75 ohm, terminated
	VIDEO OUT (PHONO);	1.0 Vp-p,	75 ohm, terminated
	S-VIDEO OUT;	1.0 Vp-p,	75 ohm, terminated
	RF Modulated;	UHF channel 36 ( $\pm 4$ ),	75 ohm

## AUDIO

<b>Input Level:</b>	AV1/AV2;	-6 dBV,	more than 10 kohm
	AUDIO IN (AV3) (PHONO);	-10 dBV,	more than 47 kohm
	MICROPHONE (M3);	-70 dBV	
<b>Output Level:</b>	AV1/AV2;	-6 dBV,	less than 1 kohm
	AUDIO OUT (PHONO);	-8 dBV,	less than 1 kohm
	HEADPHONES;	-30 dBV,	8 ohm
<b>Audio Track:</b>	1 track (Normal-mono only), 2 channels (Hi-Fi sound-stereo)		

<b>Video Horizontal Resolution:</b>	Colour; more than 240 lines (VHS/SP) more than 400 lines (S-VHS/S-Video Socket)
-------------------------------------	--

<b>Dynamic Range:</b>	Audio; more than 90 dB (Hi-Fi audio track)
-----------------------	--

<b>Audio Frequency Response:</b>	20 Hz-20 kHz
----------------------------------	--------------

<b>Wow and Flutter:</b>	0.005% Wrms/Hi-Fi
-------------------------	-------------------

<b>Operating Temperature:</b>	5°C-40°C
-------------------------------	----------

<b>Operating Humidity:</b>	35%-80%
----------------------------	---------

<b>Weight:</b>	7.4 kg
----------------	--------

<b>Dimensions:</b>	430 (W) x 120 (H) x 398 (D) mm
--------------------	--------------------------------

<b>Standard Accessories:</b>	1 pc. RF Coaxial Cable
	1 pc. Remote Controller
	2 pcs. "R6" Size Batteries
	1 pc. Stereo Type Phono Cable
	1 pc. AC Mains Lead
	1 pc. Edit Cable
	1 pc. S-Video Cable

Weight and dimensions shown are approximate.  
Specifications are subject to change without notice.